

# CLAYTON TOWN CENTER SPECIFIC PLAN

**Adopted  
March 6, 1990**

**Amended April 3, 2012**

**Clayton Community Development Department  
6000 Heritage Trail, Clayton, California 94517  
[www.ci.clayton.ca.us](http://www.ci.clayton.ca.us)**

## Appendix F. Amendments

The text, tables, and figures of the Town Center Specific Plan have been revised to incorporate the following amendments.

Resolution No. 65-98	Adopted December 1, 1998
Resolution No. 58-2001	Adopted September 18, 2001
Resolution No. 24-2004	Adopted June 1, 2004
Resolution No. 45-2005	Adopted July 19, 2005
Resolution No. 02-2007	Adopted January 16, 2007
Resolution No. 05-2008	Adopted February 5, 2008
Resolution No. 12-2012	Adopted April 3, 2012

# Table of Contents

<b>CHAPTER 1 INTRODUCTION</b> .....	1
<i>BACKGROUND</i> .....	1
Why a Specific Plan?.....	1
Planning Area.....	2
Contents.....	2
The Planning Process.....	4
Adoption.....	6
Amendments.....	7
<b>CHAPTER 2 LAND USE</b> .....	9
2.1 INTRODUCTION.....	9
2.2 GOALS AND POLICIES.....	9
2.3 LAND USE DESIGNATIONS.....	
Town Center Commercial.....	10
Multi-Family Low Density Residential.....	13
Multi-Family Medium Density Residential.....	13
Institutional Residential.....	13
Public Facility.....	14
2.4 HISTORIC RESOURCES.....	14
<b>CHAPTER 3 MUNICIPAL SERVICES</b> .....	23
<i>STORM DRAINAGE</i> .....	23
Background.....	23
Effect of Development on Flows.....	24
On-site Drainage Improvements.....	25
Off-site Drainage Improvements.....	26
Drainage Improvement Costs.....	26
<i>WATER</i> .....	26
Quality and Supply.....	26
Distribution.....	26
Planned Local Improvements.....	27
Water Service Policies.....	27
<i>SEWER SERVICE</i> .....	27
Sewage Treatment and Capacity.....	28
Collection System Needs.....	28
Sewer Service Policies.....	28

Clayton Town Center Specific Plan

---

<b>FIRE PROTECTION</b> .....	29
<b>POLICE</b> .....	29
<b>POSTAL SERVICE</b> .....	29
<b>CHAPTER 4 URBAN DESIGN</b> .....	31
<b>INTRODUCTION</b> .....	31
Design Review in Clayton.....	31
<b>THE EXISTING TOWN CENTER</b> .....	32
Key element of Clayton's Town Center.....	33
The Natural Setting.....	33
The Town Center Plan.....	34
Building-Street Edges.....	34
Yards and Open Spaces.....	35
Architecture.....	35
<b>URBAN DESIGN GOAL, OBJECTIVES, AND POLICIES</b> .....	36
Goal.....	36
Cohesive Town Center.....	36
Community and Civic Focus.....	36
Historic Significance.....	37
Open Space.....	38
Strengthen Village Character.....	39
<b>ILLUSTRATIVE SITE PLAN</b> .....	39
<b>THE DESIGN GUIDELINES</b> .....	40
Site Design.....	40
Site analysis.....	40
General Site Design Criteria.....	41
Preservation of Existing Natural Features.....	41
Circulation and Parking.....	42
Internal Site Design.....	42
The Building-Street Edge.....	43
Yards and Courtyards.....	44
Front Yards.....	45
Courtyards.....	45
Architectural Character.....	45
Building Form.....	45
Size and Bulk.....	45
Roof Forms.....	47
Porches.....	48
Building Bases.....	49

---

Table of Contents

---

Window Openings.....	49
Principles of Composition: Scale, Proportion, and Rhythm.....	50
<i>Scale</i> .....	50
<i>Proportion</i> .....	51
<i>Rhythm</i> .....	52
<i>Shade and Shadow</i> .....	52
Building Materials, Texture, and Color.....	52
<i>Exterior Walls</i> .....	52
<i>Roofs</i> .....	52
<i>Details</i> .....	53
<i>Walls</i> .....	53
<i>Roofs</i> .....	53
Pedestrian Walkways .....	53
Walls, Fences, and Accessory Structures .....	54
<i>Solid Walls</i> .....	54
<i>Materials of Fences and Walls</i> .....	54
<i>Accessory Structures</i> .....	55
Landscape Character .....	56
Preservation of Historic Buildings.....	59
Guidelines for Design Review.....	60
Relationship of New to Existing Development.....	60
Site Planning Considerations.....	60
Architectural Relationships between New and Existing Buildings.....	61
Parking Areas.....	61
On-Street Parking.....	61
Off-Street Parking .....	61
<i>Parking lot perimeters</i> .....	62
<i>Internal parking lot planting</i> .....	62
Signs .....	63
General Design Criteria .....	63
Recommended Sign Types.....	63
Sign Area and Number .....	64
Prohibited Signs.....	66
Site Lighting .....	66
General Requirements.....	66
Parking Area Lighting .....	66
Walkway, Garden, and Pedestrian Area Lighting .....	67
Building Equipment and Services.....	67
Streetscape Design Guidelines .....	68
Concrete sidewalk and vertical curb .....	69
Street light fixture.....	70
Street trees .....	70
Street tree base .....	70
Benches.....	70

Clayton Town Center Specific Plan

---

<b>GUIDELINES FOR SPECIAL AREA AND SITES.....</b>	<b>71</b>
New City Hall Site.....	71
Main Street West of Marsh Creek Road.....	72
The Grove .....	73
<b>DESIGN REVIEW SUBMITTAL REQUIREMENTS.....</b>	<b>75</b>
Preliminary Review.....	75
Submittal Requirements .....	75
<b>Site Analysis .....</b>	<b>75</b>
<i>Basic site information.....</i>	<i>75</i>
<i>Existing natural features .....</i>	<i>76</i>
<i>Cultural Resources Assessment.....</i>	<i>76</i>
<i>Photographs of the site and neighboring environment.....</i>	<i>76</i>
<i>Written summary .....</i>	<i>76</i>
<b>Site Plan .....</b>	<b>76</b>
<i>Boundaries and public improvements.....</i>	<i>76</i>
<i>Streets, sidewalks, and parking areas within the site.....</i>	<i>76</i>
<i>Structures .....</i>	<i>77</i>
<i>Location of dumpsters and loading area.....</i>	<i>77</i>
<i>Grading and drainage .....</i>	<i>77</i>
<b>Landscape Plan.....</b>	<b>77</b>
<i>Location of existing trees .....</i>	<i>77</i>
<i>Location and size of all new plant material.....</i>	<i>77</i>
<i>Method of irrigation .....</i>	<i>77</i>
<i>Means of erosion control .....</i>	<i>77</i>
<b>Building Floor Plans.....</b>	<b>77</b>
<b>Building Elevations .....</b>	<b>77</b>
<b>Sections.....</b>	<b>78</b>
<b>Signs .....</b>	<b>78</b>
<b>Lighting .....</b>	<b>78</b>
<b>Statistical Summary.....</b>	<b>78</b>
<b>CHAPTER 5 CIRCULATION ELEMENT.....</b>	<b>79</b>
<b>DESCRIPTION OF EXISTING CONDITIONS.....</b>	<b>79</b>
Regional and Local Roadways .....	79
Intersection Levels of Service in 1988.....	79
Programmed Improvements.....	81
Parking .....	82
Transit, Bicycle, and Pedestrian Circulation .....	82
Bicycle/Pedestrian Facilities .....	82
<b>ISSUES.....</b>	<b>83</b>
Connection between Marsh Creek Road and Clayton Road .....	83
Oakhurst Boulevard Extension .....	85
Main Street Configuration.....	85

Table of Contents

---

<b>CIRCULATION GOALS AND STANDARDS</b> .....	86
Roadway Improvements.....	86
Street/Road Design Standards.....	86
Parking Supply and Design .....	86
Parking Standards.....	89
Transit Service, Bicycle, and Pedestrian Circulation .....	91
Bicycles and Pedestrians.....	91
Sidewalks.....	91
Bicycles .....	93
<b>COSTS AND SCHEDULE</b> .....	93
Costs .....	93
Schedule .....	93
<b>CHAPTER 6 FINANCIAL IMPLEMENTATION</b> .....	95
<b>MELLO-ROOS COMMUNITY FACILITIES DISTRICTS</b> .....	95
<b>ASSESSMENT DISTRICTS</b> .....	96
Municipal Improvement Acts of 1911 and 1913.....	96
Benefit Assessment Act of 1982.....	97
Landscaping and Lighting Act of 1972.....	97
Vehicle Parking District Law of 1943 .....	98
Street and Lighting Act of 1919 and 1931 .....	98
<b>MAINTENANCE DISTRICTS</b> .....	100
Improvement Act of 1911 .....	100
Open Space Maintenance Act.....	100
<b>COMMUNITY REHABILITATION DISTRICTS</b> .....	101
<b>REDEVELOPMENT DISTRICTS</b> .....	102
<b>GENERAL OBLIGATION BONDS</b> .....	103
<b>PARKING LAW OF 1949</b> .....	104
<b>PARKING AND BUSINESS IMPROVEMENT AREAS</b> .....	104
<b>PARKING DISTRICT LAW</b> .....	106
<b>CERTIFICATES OF PARTICIPATION</b> .....	106
<b>DEVELOPMENT FEES</b> .....	107
<b>REVOLVING LOAN FUNDS AND TRUSTS</b> .....	108
<b>FEDERAL ECONOMIC DEVELOPMENT ADMINISTRATION (EDA)</b> .....	109
<b>STATE OF CALIFORNIA COMMUNITY DEVELOPMENT BLOCK GRANTS</b> .	110
<b>CREEKS, OPEN SPACE, AND TRAILS</b> .....	111
Urban Stream Restoration Program .....	111
California Department of Fish and Game .....	111
State Water Resources Control Board .....	112
Trails Grant Program .....	114
Land and Water Conservation Fund Program .....	114
Special Districts Grant Program .....	115

---

**APPENDIX A Preservation of Mature Trees..... 117**  
**APPENDIX B Plant Selection Guide..... 121**  
**APPENDIX C General Plan Objectives and Policies..... 125**  
**APPENDIX D Designating and Acquiring Private Property for Public Benefit .. 133**  
**APPENDIX E Summary of the Market Analysis for the Clayton Town Center  
Specific Plan ..... 139**  
**APPENDIX F Amendments ..... 142**

## List of Figures

1-1	Planning Area Boundary .....	3
2-1	Land Use Plan .....	11
3-1	Effect of Development on Peak Storm Flows .....	25
4-1	Building with front porch .....	34
4-2	Front yard spaces on Main Street.....	34
4-3	Illustrative Site Plan .....	following page 38
4-4	Site Analysis Considerations .....	40
4-5	Clayton-Pape House.....	51
4-6	Stone Wall .....	55
4-7	Traditional Wood Picket Fence.....	55
4-8	Horizontal Rail Fencing Painted to Match Trim.....	55
4-9	Landscape Plan for the Town Center .....	following page 58
4-10	Sign Types.....	64
4-11	Measuring a Boxed Sign.....	65
4-12	Measuring an Unboxed Sign.....	65
4-13	Possible Main Street Cross-Section with Parallel Parking One Side .....	68
4-14	Main Street-Corner with Streetscape Elements .....	69
4-15	New City Hall Site .....	71
4-16	Main Street West of Marsh Creek Road .....	72
4-17	The Grove.....	73

5-1	Intersection Level of Service Definitions .....	80
5-2	Existing Traffic Levels of Service .....	80
5-3	County Connection Departures from Clayton Town Center .....	82
5-4	Roadway Sections .....	87
5-5	Parking Demand .....	88
5-6	Proposed Cross-Section for Main Street .....	89
5-7	Parking Standards .....	90
5-8	Planned Sidewalks .....	92
5-9	Cost Estimates .....	94
6-1	Summary of Grant Programs Under Proposition 70 .....	113

# CHAPTER 1. INTRODUCTION

## **BACKGROUND**

Clayton is located in central Contra Costa County, southeast of the City of Concord and north of Mt. Diablo. Clayton's population in 1988 was 6,725.

In 1987, the City approved a 1,485-unit development on the Keller Ranch, north and east of the existing community, and adjacent to Clayton's historic downtown. The new development will approximately double Clayton's acreage and population.

Two important components of the final development plan for Keller Ranch approved by the City were the extension of Clayton Road as a four-lane bypass north and east of the existing downtown, and the inclusion of approximately 15 acres of future commercial land on the downtown side of the new bypass. Grading for the development began in 1988.

### **Why a Specific Plan?**

A Specific Plan had been prepared and adopted for downtown Clayton in 1981. It was superseded by approval of the City's General Plan in 1985 which—in the Community Design Element—included detail about a new Town Center. By 1988, the City needed a new Specific Plan for the downtown that would take into account the 1985 General Plan and the approved development plan for the Keller Ranch, now known as Oakhurst.

The Specific Plan covers the same subjects as the General Plan, but in greater detail and for a smaller and specific area. It provides a clear set of policies and regulations focused on the Town Center. These include distribution of land uses, location and size of streets, walks, and other infrastructure, standards for development, and methods of financing public improvements.

The new Specific Plan covers not only the historic downtown, but the 15 acres of commercial being added on its east, as well. Issues to be analyzed, as identified in joint sessions held by the City Council and Planning Commission, with historical society and business community representatives in attendance, included—

- Circulation:
- Parking;
- Storm drainage;
- Creek maintenance;
- Retention of an historic tree grove;
- Preservation of historic downtown buildings;
- Compatibility between the historic and new sections of the downtown; and
- The long term viability of the expanded commercial area, to be known as the Town Center.

## Clayton Town Center Specific Plan

---

### Planning Area

The area covered by the Town Center Specific Plan is shown in Figure 1-1.

(Amended by Resolution 65-98, dated 12/1/98; Resolution 02-2007, dated January 16, 2007)

### Contents

The Specific Plan was prepared in two parts. The first part—a Market Analysis<sup>1</sup>—analyzed the potential for developing commercial uses in the Town Center. The second part, based on estimates in the market analysis of the potential commercial floor area (square footage) that could be attracted to the Town Center, focused on an arrangement of roads, buildings, and uses that would continue the character of the historic downtown.

It is the outcome of this second part of the work that is presented in this document, in six chapters:

**Chapter 1, Introduction**, includes the reasons for the Specific Plan, depicts the area it covers, outlines the overall content of the Plan, and describes the planning process employed.

**Chapter 2, Land Use**, includes the Land Use Plan map, a description of the land use categories and what uses are allowed in them, a quantification of space by land use category, and a comparison of the Market Analysis with the commercial space provided by the plan. Of primary importance is a list of revisions to goals, objectives, and policies in the Community Design Element of the Clayton General Plan to be made by amending the General Plan.

**Chapter 3, Municipal Services**, covers storm drainage in the town center, the effect of new development on storm flows, water quality, supply, and distribution, sewer service, and fire and police protection. Proposed policies related to these subjects are set forth.

**Chapter 4, Urban Design**, describes the existing town center in design terms, sets forth urban design goals, objectives, and policies, and contains an illustrative (conceptual) plan of how the downtown might look after the Specific Plan goals, objectives, and policies are carried out. The chapter also contains a comprehensive exposition of design guidelines, streetscape design standards, guidelines for special areas and sites, and design review submittal requirements to be adopted as part of this Specific Plan. Related appendixes provide guidelines for preserving mature trees (Appendix A) and a list of acceptable plant materials (Appendix B).

---

<sup>1</sup> *Market Analysis for the Clayton Town Center Specific Plan*, Mundie & Associates, December 1988.

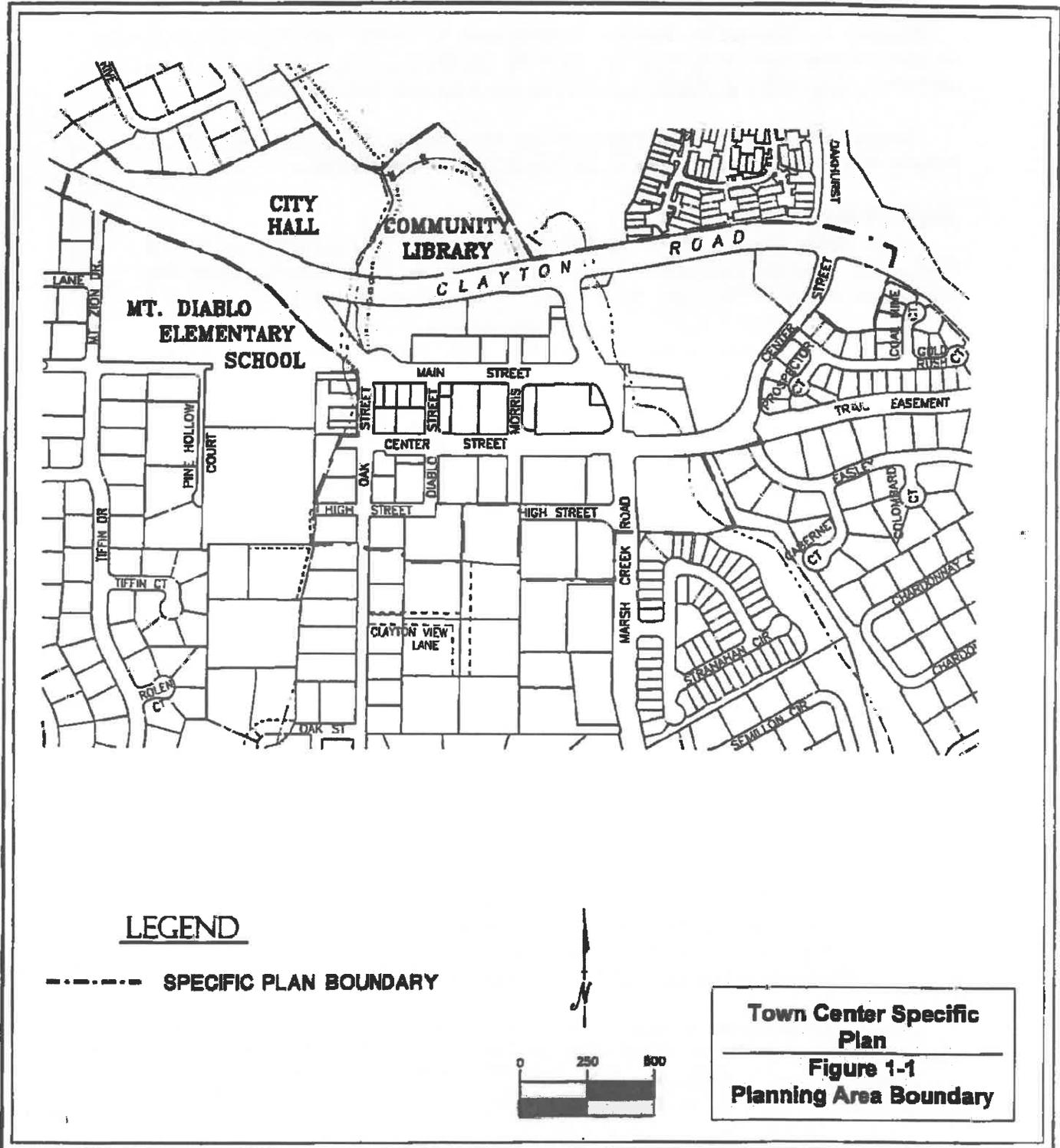

## Clayton Town Center Specific Plan

**Chapter 5, Circulation**, describes existing road and traffic conditions and major circulation issues demanding attention, sets forth circulation goals, policies, and design standards, and provides an overall cost estimate for traffic and road improvements.

**Chapter 6, Implementation**, lists and explains a number of financial mechanisms, some of which the City may be able to use to carry out the Specific Plan.

### The Planning Process

**Town Center Specific Plan Committee Meeting No. 1.** Work started on July 19, 1988, when the consulting team met with members of the Town Center Specific Plan Committee<sup>2</sup> to discuss the City's goals and establish a project schedule. In addition to the general issues listed on page 1, the consultants were instructed to—

- Consider access from the downtown to the archaeological site and historic barn and winery north of Clayton Road;<sup>3</sup>
- Consider alternative locations for a new City Hall;
- Set aside an area for the Black Diamond Trail Head at the intersection of Center Street and Clayton Road;
- Strive for a cohesive downtown—not a suburban shopping center—with as little distinction as possible between the old and new sections of the Town Center; and
- Establish one or more focal points.

The consultants then met with the Committee in a series of meetings and workshops, all well-attended by the public and members of the downtown business community.

**Meeting No. 2.** On September 20, urban design consultants Gerald Gast and Dan Hillmer showed slides of downtown Clayton and shopping areas in other small communities and discussed the Town Center's assets, problems, and opportunities. They identified the elements that give the Town Center its spatial character and identity, and presented a list of design issues that became design objectives for the Specific Plan. Among them were—

- Preserve important "view corridors";
- Keep Oak Street hill open; remove the City buildings on the west side of Oak;
- Keep the hill above (south of) Center Street in open space;
- Preserve both creeks, their banks, and their riparian vegetation;
- Preserve the knoll west of Mt. Diablo Creek;
- Preserve the western and northern "greenbelt" boundaries;
- Preserve the eucalyptus grove on the west side of Marsh Creek Road;

---

<sup>2</sup> Committee members included (in alphabetical order) Vira Bates, Carolyn Bovat, George Durbala, Glen Engle, Aggie Freeman, David Garrison, Julie Gilchrist, Mayor Ann Hall, Dave Havard, Roy Hawes, Deanna Jakel, Ken Johnson, Robert Kendall, Pete Laurence, John Lemke, Greg Manning, James C. Parsons, Julie Pierce, Connie Rehr, John Rubiales, Bob Statton, Dick Striegel (representing Presley Homes of Northern California, developers of the Oakhurst Project), Nan Wallace, and Planning Commission Chairman George Webb.

<sup>3</sup> Architects Storek and Storek, San Francisco, were engaged separately by the City to study the Cultural Center site, the DeMartini Winery, and the Keller Ranch house.

## Chapter 1, Introduction

- 
- Use and extend the existing grid street pattern to promote a “cohesive village ambience”—to make the entire Town Center feel like one district;
  - Slow the vehicular traffic and improve pedestrian activity on Main Street;
  - Permit architectural variety within a clearly defined framework; and
  - Keep the small scale of the existing downtown (one- and two-story buildings with narrow frontages).

**Meeting No. 3.** On October 4 and 10, Mundie & Associates gave a progress report and presented their preliminary findings with respect to the market the Town Center could expect to capture. A further summary was presented to the Committee and public on November 1. Figure 2-7 on page 19 summarizes the Market Analysis.

**Meeting No. 4.** A “workshop” was held on November 1 primarily to discuss two items: traffic and parking, and land use and urban design. With respect to both subject areas, problems were identified, and objectives, alternatives, and opportunities were discussed. Goals and objectives contained in the Community Design Element of the City’s General Plan, and which related to the Town Center, were presented and discussed. Two alternative sketch plans were shown, both of which extended the existing street grid into the new section of the Town Center. Among the more critical land use and circulation issues were—

- Whether western access to the Town Center would be via the existing Oak/Main Street route or a northward extension of Diablo Street in lieu of an extension of Marsh Creek Road;
- Whether limited development should be allowed in the eucalyptus grove; and
- Locations for City Hall, a new library, a new fire station, and a service station.

**Meeting No. 5.** The Committee met again on November 15 to review the issues and the effects of the various alternatives, and to decide on the alternatives to be used in the final plan. A large checklist of issues was displayed in the front of the meeting hall. Alternatives were listed in the left-hand column of the chart. In the five succeeding columns, these questions were asked about each alternative:

- *Community Value:* Does this represent a widely-held desire or overall community need?
- *Who Benefits:* Entire community? Clayton residents? Specific neighborhoods? Downtown property owners? Downtown merchants?
- *Is it Feasible*—as to engineering, cost, and codes?
- *Implementation:* Is this a necessary part of a larger project that can not proceed until this step is completed? Will this require a change order to work underway?
- *Other Concerns:* Aesthetics? Environmental impacts? Is there a risk (to persons or property) involved with this alternative that is not incurred in others?

Comments from the Committee and the public were recorded on the chart. At a mid-point in the meeting, Committee members were invited to come up to the chart and apply colored adhesive dots as a way of “voting” their preferences. Following the vote, the

## Clayton Town Center Specific Plan

---

consultants reviewed the outcome and clarified the direction being given by the Committee.

**Meeting No. 6.** Based on the Committee's direction given November 15, the consultants presented a "Town Center Conceptual Plan." (The final, approved Illustrative Site Plan is shown on Figure 4-3, following page 38.)

An important finding was that the engineering design of the Marsh Creek Road extension put it too close to Mt. Diablo Creek for the creek to be able to retain a natural appearance. As a result, the roadway pavement was narrowed from 48 feet to 38 feet and relocated westward approximately 46 feet further from the creek. A large retaining wall was replaced with an engineered slope for the west bank of the Mt. Diablo Creek adjacent to Marsh Creek Road.

**Meeting No. 7.** A draft Urban Design Element, containing design guidelines, was presented and discussed at a Committee meeting on February 21.

**Meeting No. 8.** A final draft of the Urban Design Element (Chapter 4 of this Specific Plan) was presented to and approved by the Committee at its meeting of March 29, 1989.

**Planning Commission and City Council Meetings and Hearings.** The Draft Specific Plan was published on June 7, 1989, and was widely distributed. The Planning Commission and City Council held study sessions and/or public hearings on the Draft Specific Plan on the following dates: July 19, 1989, September 12, September 24, November 7, November 16, and December 12, 1989; January 10, 1990, February 6, and February 20, 1990. Hearings on the Draft Environmental Impact Report were held on September 12 and 26, 1989.

### **Adoption**

A Specific Plan is adopted in the same manner as a general plan, except that it may be adopted by resolution or ordinance (Government Code §65453). It was never intended that every word and map in this Plan be adopted. Chapter 1 (Introduction), Chapter 6 (Implementation), the Illustrative (Conceptual) Site Plan (Figure 4-3 in Chapter 4), the Landscape Plan (Figure 4-9), and Appendixes A, B, D, and E are expressly not adopted. Chapters 2 through 5 and Appendix C are adopted as official City policy, with the exception of the Illustrative (Conceptual) Site Plan (Figure 4-3) and any language relating to it, and the Landscape Plan (Figure 4-9). Those elements of the Plan in Chapters 2 through 5 and Appendix C, as noted above, were adopted by the Clayton City Council on March 6, 1990.

---

## Amendments

Specific Plans are amended in the same manner as general plans, except that such amendments are not limited to four per year (Government Code §65453). The procedure outlined below is intended for the general guidance of the City, and persons or agencies who may wish to apply to the City to amend the Specific Plan. (More detailed information on processing and timing is available from the Planning Director.)

1. Prior to filing an official application for a Specific Plan amendment, the prospective applicant or his or her agent should discuss the proposed amendment with the City's Planning Director. This will give the applicant a first-hand opportunity to learn the details of the amendment process as well as any concerns the City may have about the proposed changes.

2. Should the applicant decide to proceed with an amendment, the next step is to file an official application with the Planning Director and pay the required processing fee.

All applications requesting a change in the Specific Plan must be accompanied by a development plan of sufficient detail to ascertain the potential impacts of the proposed project on the site and the surrounding area. What constitutes sufficient detail will be determined by the Planning Director on a case-by-case basis. Also, the Planning Director may determine, in the case of an application which deals solely with a change in the adopted text of the Plan, whether a detailed development plan will be required.

Environmental review in accordance with the provisions of the California Environmental Quality Act (CEQA) will be required of every Specific Plan amendment.

3. Once an application is submitted, it will be placed on an agenda for public hearing before the City's Planning Commission. Prior to the Planning Commission hearing, the City, in accordance with the Government Code, will provide notice to the public of the hearing date and the item to be discussed. Typically this will involve a legal notice in the *Contra Costa Times* and a notice mailed to all property owners within 300 feet of the subject property. (Public notice with respect to major amendments affecting the entire community, such as a complete update of the Plan, may be handled under alternative provisions of State law that do not require notice to be mailed to individual property owners.)

4. The Planning Director will prepare a report to the Planning Commission for the public hearing, describing in detail the proposed amendment, any environmental or other impacts that may result, and comments from other City departments or affected governmental agencies. The Planning Director's report also will state whether the Commission should recommend the amendment to the City Council for approval or denial. The staff report will be delivered to the Commission and mailed to the applicant.

**Clayton Town Center Specific Plan**

---

The staff report, comments from the applicant, and other public testimony will become factors in the Commission's action.

State law requires that any decision on a General Plan amendment must be supported by findings of fact, and the same law applies to decisions on Specific Plan amendments or revisions. Such findings will constitute the rationale for making a decision either to approve or deny the amendment. At least the following standard findings should be made for each Specific Plan amendment:

1. The proposed amendment is deemed to be in the public interest.
2. The proposed Specific Plan amendment is consistent and compatible with the City's General Plan, including any implementation programs in the General Plan that may be affected.
3. The potential impacts of the proposed amendment have been assessed and have been determined not to be detrimental to the public health, safety, or welfare.
4. The proposed amendment has been processed in accordance with the applicable provisions of the California Government Code and the California Environmental Quality Act (CEQA).

City-initiated amendments, and amendments requested by other public agencies, will be subject to the same basic process and requirements described above. This includes appropriate environmental review, public notice, and public hearings leading to an official action by Council resolution.

## CHAPTER 2. LAND USE

### **2.1 INTRODUCTION**

The land uses of the Town Center define the character and intensity of private and public activities. This chapter provides goals and policies to direct the nature of desired land uses in the Town Center as well as the protection of the district's historic resources. In addition the Town Center is prioritized as the community's focus for economic development activities and independent businesses. This chapter also lists the land uses allowed in the Town Center and provides a land use plan.

### **2.2 GOALS AND POLICIES**

**Goal I** Establish an attractive and vibrant pedestrian-friendly Town Center with a mixture of commercial, civic, recreational, and residential uses.

*Policy I.1 Support and enhance the Town Center as a vital mixed use area containing retail, restaurant, office, entertainment, civic, recreational, and residential uses. Recognize the importance of an appropriate retail mix including small local businesses, to the continued vitality of the Town Center.*

*Policy I.2 Prioritize and stimulate the development of multi-story buildings with ground floor uses which enhance pedestrian activity in the Town Center. Channel office and service uses to locations on upper floors.*

*Policy I.3 Encourage future development on Main Street and Center Street to provide a continuous row of retail shops and restaurants with as few breaks as possible in the shopping frontage.*

*Policy I.4 Encourage development of well-designed multi-story commercial buildings in order to enhance the prominence of the Town Center to motorists on Clayton Road.*

*Policy I.5 Encourage developers to seize incentives provided in the General Plan for increased structural coverage of smaller parcels in the Town Center.*

*Policy I.6 Encourage the provision of small residential units on the upper floors of commercially-designated parcels.*

**Goal II** Maintain and enhance retail and restaurant uses in the Town Center in order to sustain similar uses in the Town Center and to support the City's financial ability to provide adequate services to local residents and businesses.

*Policy II.1 Prioritize the development and expansion of retail and restaurant uses in the Town Center.*

*Policy II.2 Encourage retail and restaurant owners to utilize the flexibility provided in the City's Off-Street Parking and Loading Regulations to develop and expand their businesses.*

**Goal III Establish the Town Center as the City's focus for economic development in the community.**

*Policy III.1 Nurture and support established, expanded, and new businesses which are permitted uses (including uses permitted with a use permit) in the Town Center.*

*Policy III.2 Assist existing businesses which are non-conforming uses in the Town Center to relocate to new locations in the City.*

*Policy III.3 Encourage and support the operation of small, independent businesses and growing businesses.*

*Policy III.4 Encourage the renovation and re-use of long-term vacant or under-utilized buildings as well as the development of vacant or under-utilized parcels.*

**Goal IV Protect historical resources in the Town Center.**

*Policy IV.1 Ensure historic buildings which retain their historic character are incorporated into commercially-viable uses, re-uses, or adaptations.*

*Policy IV.2 Ensure renovations of historic buildings and structures retain the building or structure's historic character.*

*Policy IV.3 Strive to incorporate existing healthy large oaks and historically-significant trees into the open space areas of development plans.*

**2.3 LAND USE DESIGNATIONS**

The Land Use Plan is provided in Figure 2-1 and the land use designations are defined below.

**TOWN CENTER COMMERCIAL  
PERMITTED USES**

Retail sales, commercial services, and offices, as well as limited residential and visitor accommodation uses, as listed below. Uses marked by an asterisk (\*) are limited to upper floor locations, unless a use permit is granted for a ground floor location as noted in the following section.

- Antique shops
- Art galleries and frame shops
- Art and photography studios\*
- Audio/video equipment, including home theater systems
- Bakery goods stores and bakeries
- Banking
- Barber shops, beauty shops, and personal care salons\*
- Books, news stands, and magazines

Chapter 2. Land Use

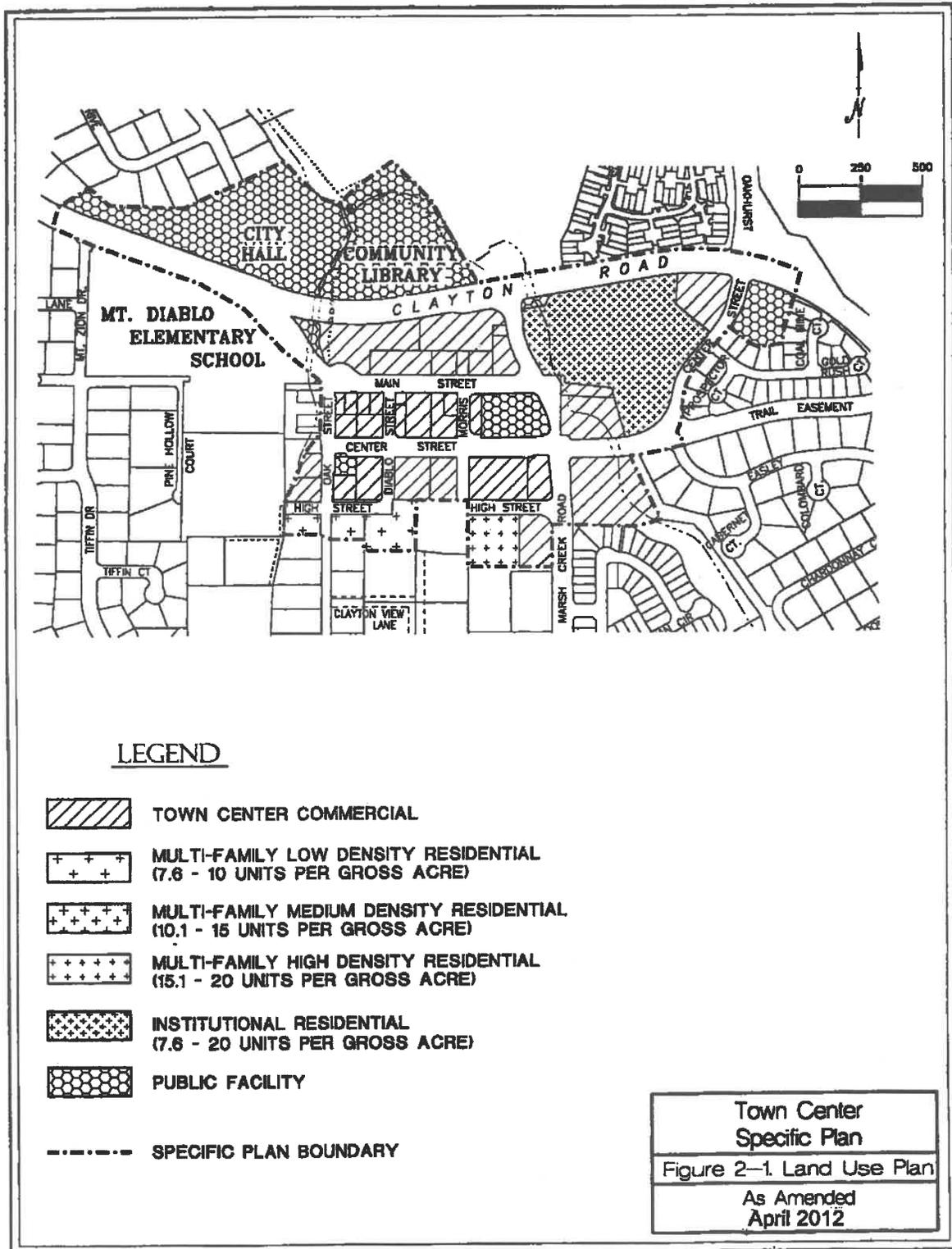

MON, MAY 07, 2012 09:35 A REAR FIG 6 A Z:\00010395 ZONING & GP MAPS\DWG\TOWN CENTER SPECIFIC PLAN V4 PROP AMENDMENTS MAY 2012.DWG

**Business, editorial, and professional offices\***  
**Camera and photographic equipment**  
**Candy and ice cream**  
**Clothing and shoes**  
**Computer, office, and electronic equipment sales**  
**Computer, office, and electronic equipment service\***  
**Copying and printing**  
**Dance, music, exercise, and martial arts studios\***  
**Drapery and yardage**  
**Drugstores**  
**Electric appliances (small appliances only)**  
**Financial services\***  
**Floor coverings**  
**Flowers and house plants**  
**Food and groceries**  
**Hardware and garden supply**  
**Interior decorating stores**  
**Jewelry, watches, and clocks**  
**Lamps and lighting**  
**Laundry and dry cleaning pick-up stores, excluding any dry-cleaning on-site**  
**Liquor, wine, and beer (off-sale)**  
**Locksmiths**  
**Luggage and leather goods**  
**Medical and dental offices\***  
**Museums (upper floors preferred)**  
**Music, including recordings, instruments, and sheet music**  
**Opticians**  
**Parking spaces and loading areas**  
**Pets and animal grooming (excluding kennels)**  
**Private mail and packaging services**  
**Real estate offices and title companies\***  
**Residential uses (upper floors only)**  
**Restaurants (including outdoor dining, on-site service, and take-out service) and associated bars**  
**Saddles and equestrian equipment**  
**Sporting goods and bicycles**  
**Stationery supplies**  
**Tailors and dressmakers\***  
**Tobacco shops**  
**Toys, hobbies, and crafts**  
**Travel agencies\***  
**Variety stores**  
**Video rentals**  
**Accessory buildings, structures, and uses clearly incidental and appurtenant to a permitted use**

Temporary and seasonal outdoor uses, subject to the Temporary Use Permit provisions (Chapter 17.70) of the Zoning Ordinance

Other retail, commercial service, or office uses which are determined by the Planning Commission (or the City Council on appeal) to be of the same general character and will not impair the present or potential use of adjacent properties.

#### **USES SUBJECT TO USE PERMIT**

The following uses are allowed only after special review and the granting of a use permit. The primary purpose of the review is to assure an appropriate mixture and balance of uses in the Town Center—a mixture and balance that the uses listed below could jeopardize, for a variety of factors including:

- The location would interfere with the pedestrian and retail orientation of the district; or
- The use or its size, in conjunction with existing uses, would overwhelm the Town Center or interfere with the pedestrian and retail orientation of the district.

Further, some of the uses listed below might require building or storage areas that would be too large or otherwise inappropriate in the Town Center:

Bars which are not part of a full-service dining establishment

Bed and breakfast guest facilities

Commercial recreation (including billiards/pool and video arcades with more than three machines);

Establishments with dancing, live entertainment, or live audio/video entertainment

Home appliances, except small electrical appliances

Home furnishings, except lamps and lighting

Massage therapy, unless part of recognized medical office or clinic

Office, commercial service, personal service, or studio uses (listed as Permitted Uses above) in ground floor locations

**MULTI-FAMILY LOW DENSITY RESIDENTIAL**—Dwelling units at a density of 7.6 to 10 units per gross acre. This designation is intended for and allows cluster units such as townhouses, garden units, and other types of planned developments, including single-family detached dwellings on smaller lots, that provide a development with amenities to balance the increased density. This density must be adequately buffered from adjacent single-family developments. Development intensity can reach 100 percent of individual parcel coverage provided that each unit has access to private outdoor space, use of recreational amenities, and provision of useable open space. Second dwelling units are allowed.

**MULTI-FAMILY MEDIUM DENSITY RESIDENTIAL**—Dwelling units at a density of 10.1 to 15 units per gross acre. Areas so designated on the Land Use Plan are deemed to have adequate site area—and are located with respect to the Town Center road system—such that the range of density can comfortably be accommodated.

**MULTI-FAMILY HIGH DENSITY RESIDENTIAL** – Dwelling units at a density of 15.1 to 20 units per gross acre. Areas so designated on the Land Use Plan are deemed to have adequate site area – and are located with respect to the Town Center road system – such that the range of density can comfortably be accommodated. This designation is intended for and allows the two-story (or higher) apartments or

## Clayton Town Center Specific Plan

---

condominiums located where higher densities may be appropriate, such as near major public transportation and commercial centers. Development within this density shall be encouraged to use a PUD concept and standards with incorporation of significant design and amenity in the project. Structural coverage, excluding recreational amenities, shall not exceed 65% of the site area.

**INSTITUTIONAL RESIDENTIAL**— Senior housing at a density of 7.6 to 20 units per gross acre. This designation is intended for development of various forms of senior housing under the sponsorship of public or quasi-public agencies. Group dining, limited vehicles, medicine-dispensing services, and other characteristics and amenities make this form of housing unique. Development intensity can reach 100 percent structural coverage for individual parcels. Structural coverage shall not exceed 50 percent of the site area.

**PUBLIC FACILITY**—Publicly-owned facilities such as government offices and facilities, community centers, museums, parks and recreational areas, the Community Library, the fire station, the Clayton Corporation Yard, and ancillary structures and uses.

### **2.4 HISTORIC RESOURCES**

The Town Center contains a variety of historic buildings, sites, and features which add character and charm to the community. Some of these historic buildings have been in continual use for commercial purposes. Other buildings have been restored or converted to various commercial and civic uses. Based upon the *Clayton Heritage Preservation Task Force Report*, the following buildings and structures are recognized as historic resources in the Town Center.

Endeavor Hall  
Keller Ranch House  
De Martini Winery  
Joel Clayton Dairy Cellar  
Keller Lane Bridge  
Clayton-Pape House  
Clayton Club  
Former Pioneer Inn  
Former La Cocotte Restaurant

PAGES 15-22 DELETED BY RESOLUTION NO. 05-2008, DATED 2/5/08

(Chapter 2 amended by Resolution No. 05-2008, dated 2/5/08)

## CHAPTER 3. MUNICIPAL SERVICES

This chapter identifies and discusses existing, proposed, and needed Specific Plan area improvements concerning drainage, water, sewerage, and fire and police protection.

### **STORM DRAINAGE**

Storm drainage improvements are needed to accommodate growth in the Specific Plan area. This section discusses general drainage patterns and the effect of development on storm drainage flows, anticipates how development is likely to affect flood potential, recommends on-site and off-site improvements, and estimates the costs of needed facilities.

#### **Background**

The Specific Plan area is located in the southern portion of the Mt. Diablo Creek Watershed, which generally flows in a northerly and westerly direction. The existing downtown area drains west to Mitchell Creek which, in turn, flows into Mt. Diablo Creek, while the new (Oakhurst) addition to the downtown drains west into Mt. Diablo Creek. Elevations in the area vary from 370 feet to 460 feet. The mean annual precipitation is 21 inches.

Flooding has occurred along Mt. Diablo Creek in the Town Center area and in the flood plain between Clayton Road and Kirker Pass Road. The major floods affecting this area occurred in 1938, 1952, 1955, and 1963. The 1955 and 1963 floods both were estimated as 25-year floods, *i.e.*, the 100-year flood has not recently occurred.<sup>1</sup>

Despite these occurrences, Mt. Diablo Creek is not considered to have a serious and continuing history of flooding. Part of the reason is the long flood plain between the slopes of Mt. Diablo and the southerly City limits that serves to slow down velocity and reduce peak flows.

The Contra Costa County Flood Control and Water Conservation District (CCCFC) oversees storm drainage improvements in Major Watershed Zone 4A, which includes the Specific Plan area. Portions of Mt. Diablo Creek are proposed to be widened. As part of the Oakhurst Country Club Conditions of Approval, the developer is working with the City hydrologist to prepare a drainage plan.

---

<sup>1</sup> Clayton 2000, General Plan Revision and EIR, Adopted July 17, 1987, page VII-11.

According to CCCFC, although much of Mt. Diablo Creek has a capacity of 1,500 to 2,000 cubic feet per second (cfs), in some areas capacity is as low as 500 cfs. Within Clayton, flood waters are controlled by berms and hills, and directed back to the creek.

Existing flood protection measures include earthen levees along the edge of the housing north of Clayton Road (downstream from the confluence of Mitchell and Mt. Diablo Creeks, at the Cardinet subdivision where the creek was widened). The City advises that, further downstream at the Morningside subdivision, private landowners have dumped loosely consolidated material on banks to provide some measure of protection from flooding. The City is concerned that this material may break away in a major storm causing serious sediment blockage of the creek.

Mt. Diablo Creek and its tributaries form an open channel system, except at road crossings. On the project site there are only a few culverts or bridges that should be noted. At Center Street in Clayton, Mt. Diablo Creek passes through existing twin 8-foot-high by 12-foot-wide reinforced concrete box culverts. Just downstream, an existing bridge (to be replaced by the Main Street Bridge) leads to the Black Diamond Trail. A triple box culvert is designed to take the creek under the intersection of Clayton Road and the extension of Marsh Creek Road. Further downstream, an existing stone bridge leads to the Keller Ranch House.

The creeks do not offer sufficient capacity at present to provide adequate flow in event of a 100-year storm.

Localized flooding and creek bank erosion has occurred at several locations along the creek where it is narrow and heavily vegetated. Estimates have been made of the capacity of Mt. Diablo Creek, but because there have been no detailed hydraulic analyses, these estimates are to be considered as approximate only. (There are no stream-gauging stations along Mt. Diablo Creek; therefore, no historical stream runoff data is available.) Generally, estimates indicate that the 25-year flood event can be accommodated in the existing Mt. Diablo Creek channel through the project site, but the channel capacity will be exceeded below Kirker Pass Road.

### **Effect of Development on Flows**

The quantity of runoff is increased as urban development takes place as more of the land surface is made impervious with the result that infiltration of water into the soil is diminished. Peak flow rates also increase with urbanization. The proposed project will alter current runoff patterns and will affect the quantity and quality of the stormwater. These effects could include flooding due to increased runoff from the site or surcharging of the existing drainage system.<sup>2</sup>

---

<sup>2</sup> WPM Planning Team, Inc., Final EIR for the Oakhurst Country Club Project, February 1987, page 8-2.

**Figure 3-1: Effect of Development on Peak Storm Flows**

Creek/Location	Tributary Area, Square Miles	Year Event	Peak Storm Flows, cfs "Build-out" Condition <sup>3</sup>
Confluence Mt. Diablo & Peacock Creeks, no. of Clayton Rd.	7.90	25	3580
		100	4820
Confluence Mitchell & Mt. Diablo Creeks, no. of Clayton Rd.	4.56	25	1400
		100	1880

**On-site Drainage Improvements**

A combination of on-site drainage improvements is needed to serve new development in the Planning Area. (Note: *The final size and location of drainage facilities can only be determined after the grading plans and street layouts with each development area are complete.*)

**Policy 1.** *New developments should maintain natural drainage patterns when possible.* Underground pipe should generally be located in street right-of-way for ease of construction and maintenance.

**Policy 2.** *Open channels should be maintained in their "natural" state.*

Within the Planning Area, Mt. Diablo and Mitchell Creeks should remain earth channels with sides sloped at horizontal-to-vertical ratios between 3:1 and 6:1 where possible. Natural grasses and shrubs should be planted on channel slopes to maintain stream bank stability and improve appearance. Slope protection along the creeks will be needed to prevent erosion and land loss.

**Policy 3.** *All open creeks should be maintained in as near natural a state as possible.* Where there still are open areas, 100 feet on each side of the stream should be kept unobstructed. Where less than 100 feet is available, a thorough hydrological study must be conducted to determine the potential flood and to design the necessary cross-sections.

<sup>3</sup> "Future Condition (Year 2030)," correspondence from Contra Costa County Flood Control District and Water Conservation District, April 4, 1989 and Roger Fry, Camp Dresser & McKee Inc., April 19, 1989.

## Off-site Drainage Improvements

**Policy 4.** *Since all Specific Plan area development will add to the flow on the Mt. Diablo Creek, special drainage (or flood mitigation) fees should be collected from Planning Area development to contribute to construction funds for Specific Plan area storm drainage and flood control improvements for Mitchell and Mt. Diablo Creeks.*

Flood Mitigation Fees for developments in the Specific Plan area would be based on future detailed engineering studies, on the overall cost of the public works needed, on the quantified share or contribution from the Specific Plan area, and on the likely availability of federal, state, and/or city funds for the drainage and flood control projects.

## Drainage Improvement Costs

Little exists in the way of ultimately usable storm drainage facilities. In order to minimize surface flows (*e.g.*, no valley gutters, pickup at each intersection), there is a need for approximately 1,500 lineal feet of storm drain (15" diameter) in the existing downtown area. The Oakhurst part of the commercial area will require approximately 2,000 additional lineal feet of line. The total cost for both areas could run as high as \$150,000.<sup>4</sup> The cost would be reduced if more surface flows—more storm water allowed to flow on City streets—were accepted.

## WATER

### Quality and Supply

Clayton is served by the Contra Costa Water District. An adequate water supply is and will be available to the Planning Area at least until the year 2000. Currently, inferior water quality, due mainly to the periodic intrusion of brackish water into the river system, is a problem. However, the Los Vaqueros Reservoir Project, now under design, will alleviate the periodic high chloride level by blending winter runoff with high chloride flows.<sup>5</sup>

### Distribution

The City's existing water distribution system was recently switched from Zone 4 to Zone 5 enabling the system to provide adequate pressure for fire protection. There are existing 6" water mains under Oak Street and Main Street, and an 8" main under Marsh Creek Road. There is also a 4" line in High Street off of Oak Street. System improve-

---

<sup>4</sup> All lineal feet and cost figures are in 1989 dollars from letter by City Engineer, dated February 8, 1989.

<sup>5</sup> Letter from Patricia E. Nelson, Associate Engineer, Contra Costa Water District, dated May 31, 1989.

ments are needed, however, to make water available to all parts of the Town Center. Higher capacity transmission lines must be installed in the Town Center area to provide adequate capacities for additional development and redevelopment.

### **Planned Local Improvements**

Water mains need to be extended throughout the downtown and the Oakhurst areas to provide loop systems. It is estimated that a total of approximately 4,000 lineal feet of line would be required, at a cost of \$120,000.

### **Water Service Policies**

The Planning Area will need a common water system, including a transmission main and secondary loops. **The goal is to have a water system that will provide for peak use, fire flow, and emergency reserve needs throughout the Planning Area.** Accordingly, the following policies are adopted as part of this Specific Plan:

*Policy 5. Allow development in the Planning Area only to the degree the CCWD is able to supply and distribute water adequate to meet the area's needs.*

*Policy 6. Provide loops as necessary to ensure continuous service and reliability of fire flow in the event of a rupture in the mains or other interruption in service.*

*Policy 7. Install mains and laterals so as to provide completed loops, these increments to be financed by the property owners and developers in the areas benefitting from the installation.*

*Policy 8. Design a water system for the Planning Area adequate to meet the user, fire, and emergency needs associated with the land use designations in this Specific Plan.*

*Policy 9. Condition all development approvals on the completion of water mains and connections, and on the availability of supply.*

### **SEWER SERVICE**

The Central Contra Costa Sanitary District (CCCSD) provides sewage treatment for the Town Center. Conveyance of sewage from this area to the treatment plant is through lines owned and operated by the City of Concord. In turn, the City of Clayton pays the District, via a contract with Concord, a treatment service charge based on gallonage, and that charge is reflected in local sewer service rates.

## **Sewage Treatment and Capacity**

The treatment plant, located in Pacheco, currently provides secondary quality treatment and tertiary water reclamation. No new plant or plant expansion is anticipated. The plant can currently treat 45 million gallons per day (mgd) which is sufficient for current use. By the year 2000, the plant will have the capacity to treat 60 mgd which will exceed full buildout.<sup>6</sup> There is one existing trunk sewer line in Main Street and Marsh Creek Road (15"-18" diameter, 10'-12' deep). The trunk line has more than adequate capacity for the existing downtown area as well as the Oakhurst commercial area. There is an existing 8" sewer line (6'-7' deep) under Oak Street. In addition, a new trunk line to serve this area, in which the Oakhurst property owners participated, has been built.

## **Collection System Needs**

Sewer lines will need to be extended to serve the properties on Center Street as well as the new Oakhurst commercial area. For ultimate buildout, 3,000 lineal feet of sewer line will be needed. This would cost approximately \$80,000 including structures and engineering. The *Sewer Capacity Study* for the Oakhurst Project states that the existing trunk line system is adequate for the ultimate development of the Clayton area which includes the downtown Specific Plan area.<sup>7</sup>

## **Sewer Service Policies**

To ensure adequate sewer service, the following policies should be applied to all development in the Planning Area:

**Policy 10.** *The necessary trunk line extensions should be constructed and partially financed by private development and then turned over to the City for operation and maintenance.*

The Redevelopment Agency encourages the installation, construction and/or reconstruction of utilities by providing tax exempt financing to these projects in conformance with the Community Redevelopment Plan. The entire Specific Plan area is within the Redevelopment Project area.

**Policy 11.** *Require that all new development in the Planning Area be connected to the City sewer system.*

**Policy 12.** *Condition the approval of all developments on the provision, by the applicant, of required sewer improvements.*

---

<sup>6</sup> Personal Conversation with Stephen McDonald, Senior Engineer, CCC Sanitary District, March 20, 1989.

<sup>7</sup> MacKay & Soms Civil Engineers, Inc., Sewer Capacity Study for the Oakhurst Project, September 1987, page 13.

**Policy 13.** *In the interest of cost efficiency, install sewer mains and laterals as roadways are built.*

Locate all utilities under streets, except PG&E lines which are placed under the back portion of sidewalks.

### **FIRE PROTECTION**

Fire and emergency services in the Planning Area are currently provided by the Contra Costa County Consolidated Fire District (CCCCFD). The existing Station #11 is situated just west of the Town Center at Clayton and Mitchell Canyon Roads. It is proposed to relocate the station to a new location in the Town Center.

The downtown area needs to be upgraded both in terms of adequate flow capacity and number of hydrants. However, no additional facilities or capital equipment, *e.g.*, pumps, will be needed to serve the Planning Area.<sup>8</sup>

### **POLICE**

Police services in the Planning Area are currently provided by the City. The station is located next to the existing city hall on the west side of Oak Street at Center. A new facility is planned in conjunction with a new city hall proposed to be constructed west of the Pioneer Inn, between Main Street and Clayton Road. The combined City Hall/police services facility will be approximately 9,000–10,000 gross square feet in size and will include a dispatch office and vehicle storage area large enough to accommodate anticipated future public safety demand.

### **POSTAL SERVICE**

The City will encourage the Postal Service to maintain a post office Downtown. The City desires to accommodate a new and larger post office anywhere in the Town Center, but especially in the older (west) end. □

---

<sup>8</sup> Letter from Elizabeth Patterson transmitting information from Inspector Nelson, CCCC Fire District, March 28, 1989.



# CHAPTER 4. URBAN DESIGN

## **INTRODUCTION**



Clayton Town Center's extraordinary natural setting, rich history and architectural heritage are a strong source of identity and value to the community. Citizens have strong feelings about preserving the Town Center's existing character while welcoming its expansion to provide needed commercial services and shopping. The purpose of the Urban Design Element is to provide clear guidelines for the Town Center's future development pattern, architecture and landscape design, so that new development retains and strengthens the existing Town Center character. (Amended by Resolution 65-98, dated 12/1/98)

The Urban Design Element describes important design principles for the Town Center's development, and includes illustrative drawings and a comprehensive set of Design Guidelines.

### **Design Review in Clayton**

All development proposals in The Town Center Specific Plan Area are subject to discretionary review by the Planning Commission. The Design Guidelines serve as adopted criteria for the evaluation of a building or an entire development. Developers and their designers are urged to carefully review The Town Center Specific Plan, with particular attention to the Design Guidelines, before site planning and building design studies begin.

Design Review is a comprehensive evaluation of those characteristics of a development which have an impact on neighboring properties and the community as a whole. The process makes a careful examination of a project's quality of site planning, architecture, landscape design and important details such as signage and lighting. The purpose

is to insure that every new development or additions to existing development carefully consider the community context in which they take place. Every project should make a conscientious effort to develop a compatible relationship to the natural setting, neighboring properties, and community design goals.

### ***THE EXISTING TOWN CENTER***

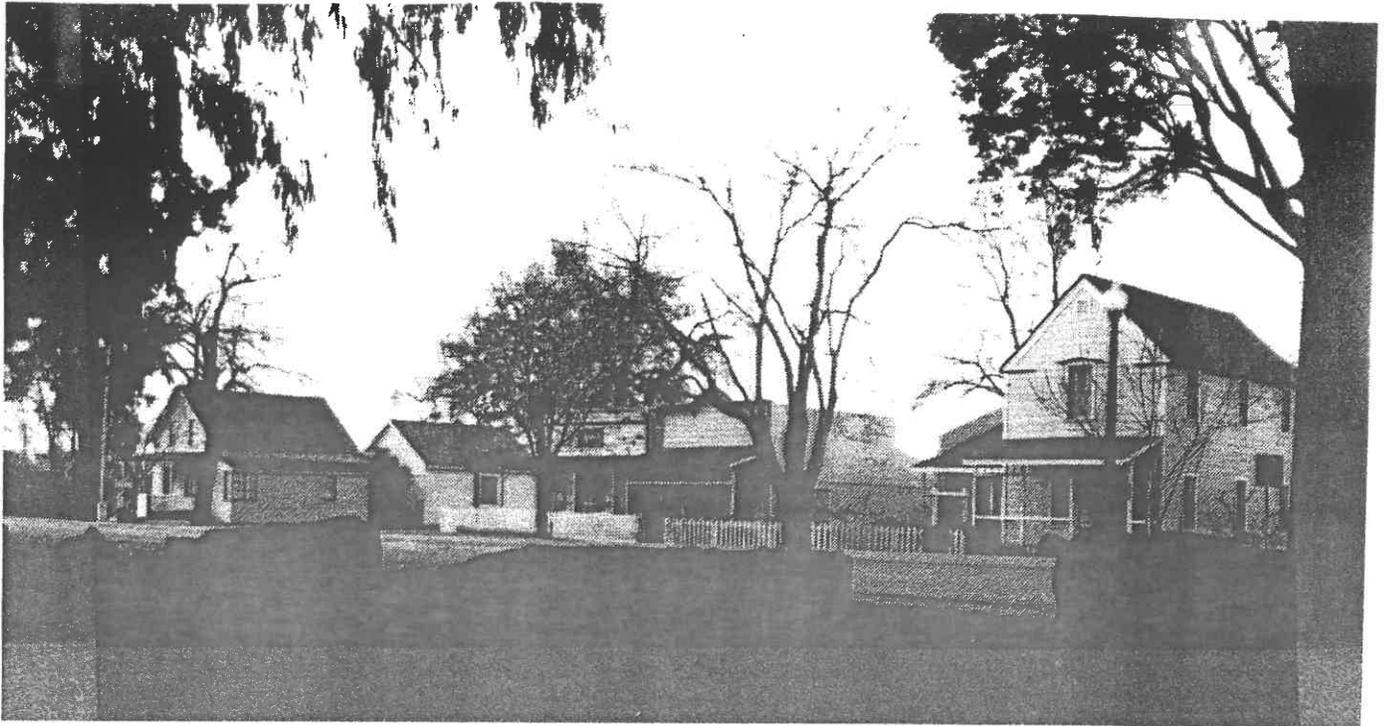

Clayton Town Center has a unique village character that results from the relationship between its natural setting, grid street pattern and modest rural architecture. These elements work together to create a distinct town “image” that residents now identify with and feel strongly about preserving.

Clayton’s Town Center began with a few houses and stores built along the small grid of streets laid out by Joel Clayton in 1857. He envisioned a prosperous community at the foot of Mt. Diablo, in an area of great beauty and agricultural wealth, central to the surrounding mines. As the town grew, miners came to enjoy the social clubs, saloons, and stores. Clayton’s boom ended when competition from mines in Oregon and Washington and the increased costs and difficulty of mining proved too great. Farmers growing grapes, wheat and other crops kept Clayton’s economy alive, but it never again

flourished as it had during the mining boom. Clayton remained a small and reasonably stable agricultural community. From that time to the present it has retained much the same character. A handful of buildings remain to continue its tradition as a rural western town.

Clayton's Main Street, with its tree canopy, fine trio of houses near Marsh Creek Road, Clayton Club and Pioneer Inn, is the lifeline of the town. The old meeting hall (Endeavor Hall) lies one block south of Main Street at Center and Oak. These buildings exhibit the different ages, styles, and cultural mix that accompanied settlement and growth in Clayton.

### Key elements of Clayton's Town Center

**The Natural Setting.** Clayton's surrounding landscape forms one of the most spectacular natural settings in the greater San Francisco Bay region. The community is laid out along Clayton Valley and Mount Diablo Creek, nestled between the range formed by Mt. Diablo, Eagle Peak, Twin Peaks and Mt. Zion to the south, and Keller Ridge-Kirker Pass to the north-northeast. The Town Center has the distinct feel of a rural village carefully placed in the valley, given strong natural definition by both foreground and distant hills. Views and outlooks to the neighboring peaks and ridges bring perception of the surrounding rugged landscape directly into the Town Center.

One of the most dramatic features of Clayton's Town Center is its western "entrance" on Clayton Road. The combination of the abrupt descent and dense tree cover creates a strong sense of entering a special world separated from the surrounding suburban landscape. Other strong natural boundaries on the north and south give the Town Center clear definition along three of its four edges. Although the Town Center's topography is relatively level, the subtle elevation changes within the setting are important:

- The Mitchell Creek and Diablo Creek embankments.
- The gentle knoll east of and above Diablo Creek, in the new development area.
- The knoll south of Center Street, between Diablo and Morris.

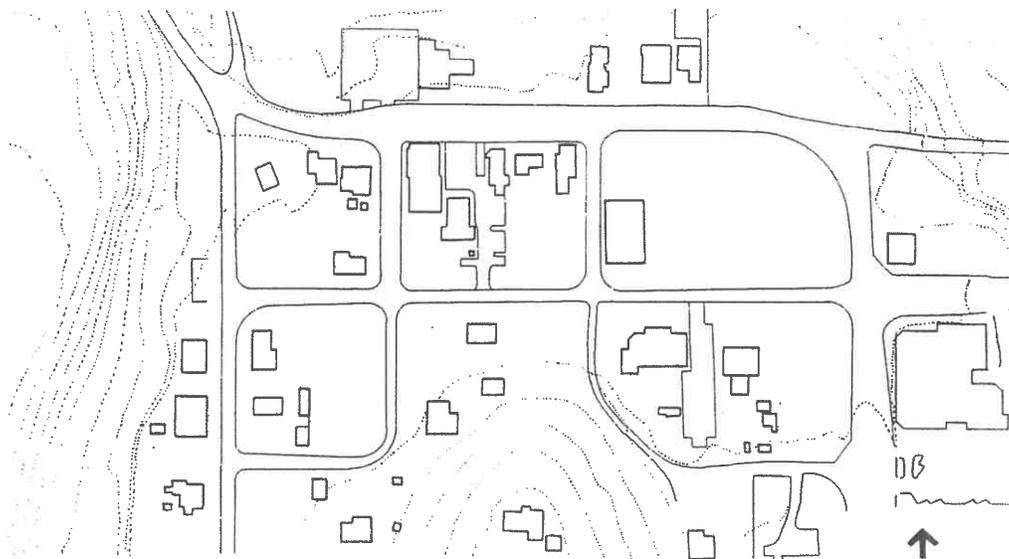

**The Town Center Plan.** The existing Town Center's street grid forms small blocks that range from 200 to 350 feet on a side. The grid contrasts with the curved patterns of rural roads and residential subdivisions of the Clayton area, and helps distinguish the Town Center from neighboring districts. The small block pattern gives the Town Center an intimate scale that pedestrians can appreciate, and creates an extra number of corner buildings and sites with high visibility. Occasionally, the street grid is interrupted by topographical features, as in the hill south of Center and Morris, increasing one's awareness of the natural setting.

### **Building–Street Edges**

The older buildings of the Town Center form three *desirable* relationships of buildings to streets:

- Building with a front porch located at the sidewalk (Clayton Club).
- Yard or patio between the building and street (LaCocotte, Clayton Historical Society Museum).
- Building located on the front property line (Realty and Post Office at Main and Diablo Streets).

Each of these examples creates a strong pedestrian connection between building fronts and streets common to older towns and villages.

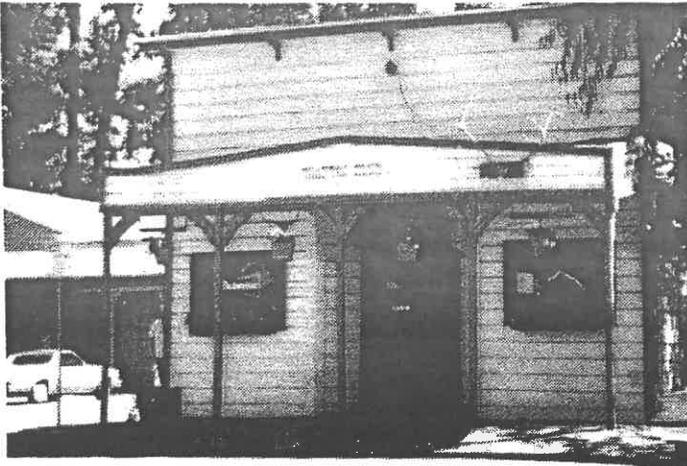

**Figure 4-1:** Building with front porch (Clayton Club)



**Figure 4-2:** Front yard spaces on Main Street

**Yards and Open Spaces.** The quilt-like pattern of alternating buildings and yards, organized by the grid of streets and individual lot lines, creates a spaciousness throughout the existing Town Center and allows through-block outlooks to the surrounding natural landscape. Mature trees define and shade the open spaces, creating a dense canopy over most of the setting, further emphasizing its special character apart from the surrounding open valleys and hills.



**Architecture.** Clayton Town Center's modest wood frame buildings develop a local vernacular with a genuine sense of antiquity and history. Horizontal wood siding, foundations of local stone, and other natural materials are combined in carpenter-built small structures with moderate-to-steep pitched roofs, frequent emphasis of porches and other protected outdoor spaces, roof overhangs and eaves, and orderly use of window openings. Several styles can be found ranging from the western false front of the Clayton Club to the rural vernacular of the Clayton-Pape House and Endeavor Hall. Many of the details recall "Craftsman," "Victorian," and other styles.



## **URBAN DESIGN GOALS, OBJECTIVES, AND POLICIES**

### **Goal**

**Maintain the rural and historical character of Clayton in the central area of the City and its neighborhoods.** *(From the Clayton General Plan)*

### **Cohesive Town Center**

**Objective 1.** *Create a clearly-defined, cohesive Town Center, integrating old and new to attain the feel of the entire Center being one place.*

#### Policies

- 1a. Adopt consistent design standards for street and sidewalk spaces throughout the Town Center. Sidewalk paving, curbs, street tree planting, and street furniture should be carefully coordinated as integrating visual elements.*
  - 1b. Maintain strong architectural standards to develop continuity between old and new buildings, in infill situations in the existing Town Center, and in the newly-developing area.*
- (Amended by Resolution 65-98, dated 12/1/98)

### **Community and Civic Focus**

**Objective 2.** *Emphasize the Town Center as the focus of community life in Clayton, integrating civic, cultural, shopping, and recreational functions into a multi-use district.*

#### Policies

- 2a. Create public places in the Town Center where residents can meet informally.*
- 2b. Build a new City Hall at a prominent location at the west end of Main Street, emphasizing its character as a town hall in the historic American tradition—a focus for community services and accessible local government.*

The phrase, “a prominent location at the west end of Main Street,” is intended to allow some flexibility in the location of a City Hall. The Plan clearly intends that the City Hall be located south of Clayton Road and west of Marsh Creek Road, and as close to Main Street as practicable. Objectives discussed during the planning process include strengthening the older (west) end of the Downtown, attracting people into the retail core by bringing them to City Hall, and making the Downtown not just a commercial center, but the civic focus of the community as well. As of 1989–1990, a City Council-appointed committee was studying potential sites for a new City Hall, as well as its interior needs and exterior appearance. While the charge to the

committee admonished that committee proposals must be compatible with the Town Center Specific Plan, this Specific Plan nevertheless recognizes that the committee may make recommendations that are more detailed than, or at modest variance with, recommendations in this Plan. It is the intent of this Plan to accommodate such recommendations without the need for formal revision of the Plan, provided that the recommendations accomplish the objectives noted above. Should, however, the Committee recommend a location outside of the boundaries noted above, formal public hearings should be held to consider those recommendations and whether the Specific Plan should be revised accordingly.

- 2c. *Retain existing public services, such as the Post Office; and locate new public services such as the County Library and Fire Station, in the Town Center.*
- 2d. *Emphasize the Town Center character as a place for pedestrian enjoyment, following the traditional building-to-street relationship of older towns and villages. Buildings are to be located at the front of properties near the sidewalk, with active, well-scaled frontages that create pedestrian interest. Parking lots are to be located to the rear of buildings, well-planted and screened from street view.*

## **Historic Significance**

**Objective 3.** *Establish an historical area where structures and sites of historic significance are located.*

### Policies

- 3a. *Consider State and National Historic District designation for the existing Town Center.*
- 3b. *Consider State and National Historic designation for qualifying individual sites and buildings.*
- 3c. *Seek State Office of Historic Preservation (SOHP) Certification and develop an historic “district” comprehensive plan. Include appropriate buffer zones where necessary.*
- 3d. *Adopt a City historic preservation ordinance which includes provisions for Conservation Easements on historic buildings.*
- 3e. *Use the Town Center Specific Plan, including Design Guidelines, for Design Review of all new development proposals and additions to or alteration of existing structures.*

Just as a City Hall can attract people to Downtown who might otherwise not come there, so too the Historical Society Museum (located in the Clayton-Pape House on Main Street) can attract people and thus enhance the vitality and economic success of the Downtown. The village-like character of the existing Town Center owes much to the fine trio of buildings—Clayton-Pape house, LaCocotte restaurant, and the replica of the Scamon house at 6123 Main Street near Marsh Creek Road. The Clayton-Pape house is located on a City-owned right-of-way, and the City Council in 1989 promised the Historical Society, whose museum is in the Clayton-Pape house, that the Museum would not have to relocate for four years. As of 1989, a committee was studying whether a more suitable location could be found for the museum, but it was clearly understood that the museum would move only if one of the following conditions applied: (1) either a more appropriate site is found, or (2) the City needs the underlying site for street or driveway. This Plan recommends that if the Museum is moved because a more appropriate site is found, it should be replaced by a building very much in the scale and manner of the Clayton-Pape house.

## Open Space

**Objective 4.** *Maintain the Town Center's landscape and natural vegetation as a means to provide greenery, open space, development buffers, and a rural atmosphere.*

### Policies

- 4a. *Preserve Mitchell Creek and Diablo Creek in their natural settings as important features and open space amenities of the Town Center.*
  
- 4b. *Develop a park at the southwest corner of Main Street and Marsh Creek Road to serve as the primary public open space in the Town Center.*  
(Amended by Resolution No. 02-2007, dated 1/16/2007)
  
- 4c. *Preserve the DeMartini Winery and Keller Ranch (Cultural Center) sites on the north side of Clayton Road as continuous public open space forming the northern boundary of the Town Center.*

Revised January 2007

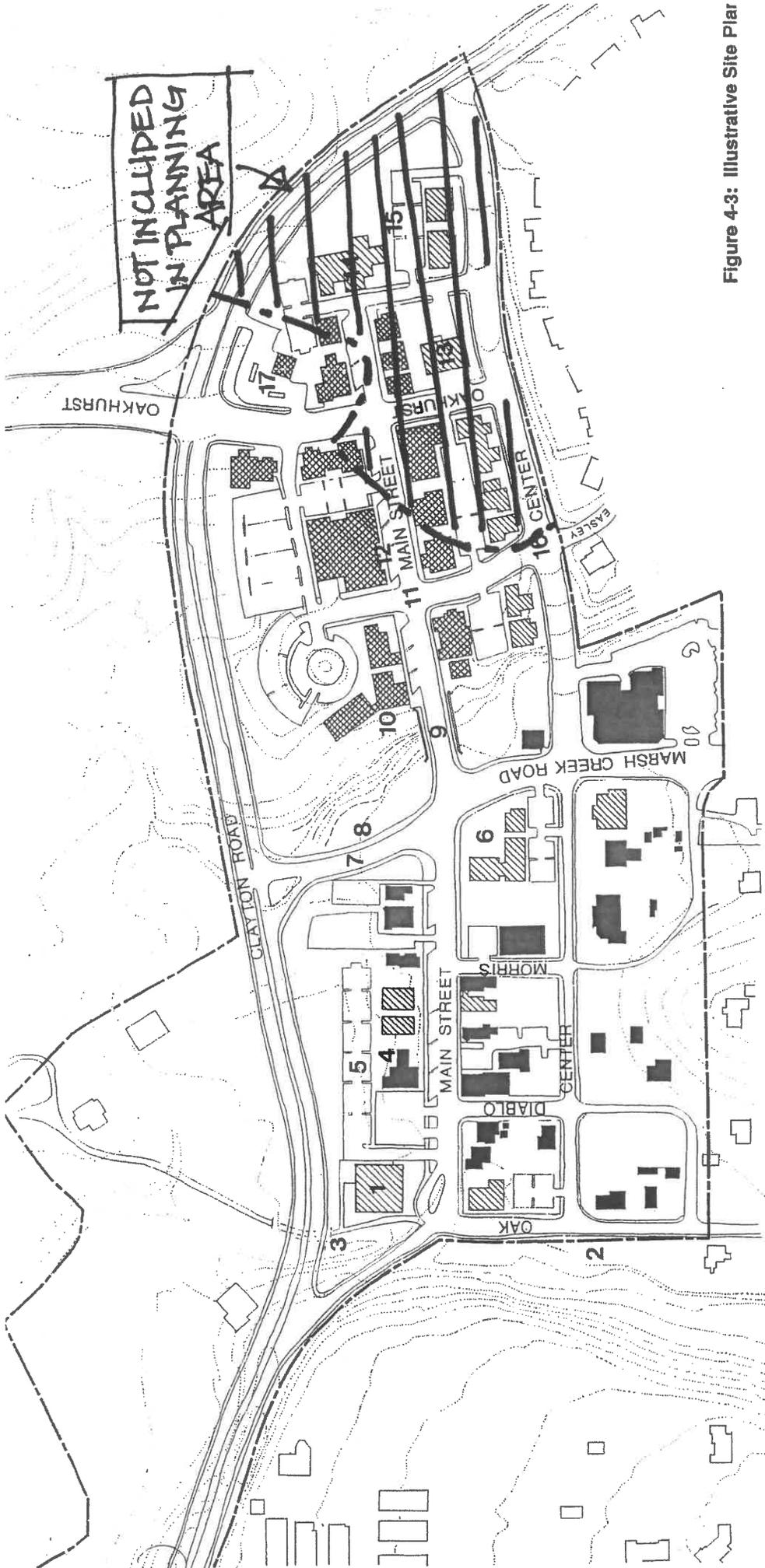

NOT INCLUDED  
IN PLANNING  
AREA

**TOWN CENTER  
SPECIFIC PLAN  
AMENDED BY  
PN 05-98, DATED 12-1-98**  
City of Clayton, California

-  EXISTING BUILDINGS
-  DEVELOPMENT PROJECTED BY MARKET STUDY
-  OTHER POTENTIAL DEVELOPMENT

- 1 City Hall, west end of Main Street
- 2 Mitchell Creek Park
- 3 Pedestrian Tunnel to Cultural Center and Winery
- 4 Pioneer Inn
- 5 Future Public Parking, with low stone wall and landscape screen along Clayton Road
- 6 The Grove, enclosed by new commercial development with most existing trees retained
- 7 Marsh Creek Road extension
- 8 Creekside Bicycle/Pedestrian Path
- 9 Main Street "Stone Bridge" feature
- 10 Creekside Restaurants and Shops
- 11 Eastern Extension of Main Street; focus for convenience shopping; diagonal parking on north or both sides
- 12 Grocery Store or Supermarket
- 13 Fire Station
- 14 Public Building (e.g., Library); one-story height to preserve view east to Keller Ridge
- 15 Trailhead and Public Parking
- 16 Potential for Residential on Center St.
- 17 Automobile Service Station

**Figure 4-3: Illustrative Site Plan**  
Note: This map is not dimensionally accurate and can not be relied upon to measurements of distance or land area

Naphthall H. Knox & Associates, Inc.  
Baron-Archman Associates, Inc.  
Gerard Ober, AIA, & Daniel Hillmer, AIA, Urban Design  
Alumda & Associates  
Garrett Eckbo, ASLA

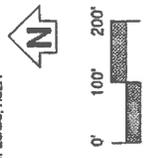

- 4d. *Develop a densely-planted buffer along the south edge of the new Clayton Road right-of-way. The buffer should screen the view of parked cars, but not block views of the distant hills.*
- 4e. *Adopt strong design standards to retain existing mature trees and other natural features in new development.*
- 4f. *Provide direct pedestrian linkages between the Town Center and the regional trail system.*
- 4g. *Retain the Town Center's existing pattern of yards and open spaces, including the opportunity for outlooks to the surrounding foothills, by requiring yards, courtyards, or other open spaces in each new development.*

(Amended by Resolution No. 02-2007, dated 1/16/2007)

### **Strengthen Village Character**

**Objective 5.** *Eliminate physical elements that detract from the Town Center's rural village character.*

#### Policies

- 5a. *Require underground utilities in all new development.*
- 5b. *Adopt strong controls on commercial signage, especially illuminated signs.*
- 5c. *Adopt strong standards on the location of service areas, dumpsters and mechanical equipment.*

### **ILLUSTRATIVE SITE PLAN**

The Illustrative Site Plan (the fold-out map preceding this page) shows a concept for the locations of streets, public facilities, and open spaces in the Clayton Town Center Specific Plan area. Building “footprints” of potential development on private parcels are based on an earlier land use plan (since revised) and are shown for illustrative purposes only; they are not to be taken as a literal depiction of future development. The Illustrative Site Plan shows the pattern that would result from the Specific Plan's development standards and design guidelines, but the standards and guidelines themselves are the adopted criteria that will shape the development.

Revised January 2007

---

## **THE DESIGN GUIDELINES**

The guidelines are intended to be met, not ignored. They are more than suggestions, but less than absolute requirements, in order to allow for some flexibility in meeting the intent of the guidelines. The standards should be looked upon as being firm from a qualitative—but not from a quantitative—standpoint.

Recognizing that the guidelines offer a variety of ways to meet Town Center design objectives, this Specific Plan gives absolute authority to the Planning Commission and the City Council to approve or deny a building design or proposed use based on whether the project as proposed meets these design guidelines.

### **Site Design**

The quality of site design is the most important measure of a project's impact on the community and will be given first priority in the review of development proposals. Projects should demonstrate sensitivity to both the natural setting and to the neighborhood context. A project should also contribute to the Specific Plan urban design goals, objectives, and policies.

**Site analysis.** Each development proposal should include a thorough analysis of existing conditions on and adjacent to the site. A proper analysis will include a careful examination of a site's physical properties, amenities, special problems, and character, and an examination of the neighboring environment. The analysis will assist the Planning Commission in evaluating the proposed development's relationship to existing conditions, neighboring properties, and the community at large.

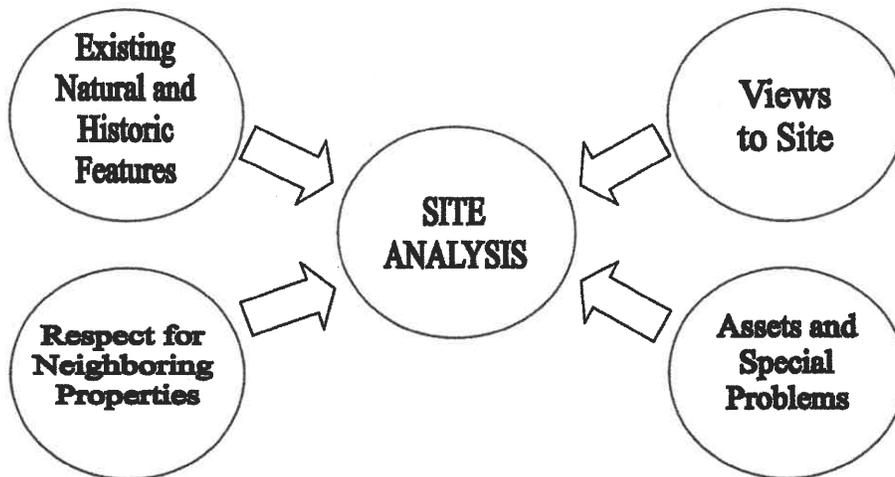

**Figure 4-4: Site Analysis Considerations**

Although the steps in an analysis will vary with the unique situation of each site and project, the following information is normally needed:

- **Basic Site Data:** boundaries and dimensions; location of adjacent streets, sidewalks, and rights-of-way; location of setback lines and easements; existing structures and other built improvements.
- **Existing Natural Features:** location, size, and species of trees and other important vegetation; topography, with areas of slope over 25% highlighted; patterns of surface drainage; location of flood plain; soil capability; ground water elevation; and other important features that are either amenities or potential hazards in development.
- **Neighboring Environment:** views to the site; land use and site organization of neighboring properties; form and character of neighboring buildings; important site details on neighboring properties which can be seen from the street.

#### **General Site Design Criteria**

- Demonstrate an overall design integrity and a serious effort to contribute to the beauty and harmony of the community.
- Develop compatible relationships to the land forms, building placement, and existing open spaces of neighboring properties.
- Respect the existing views, privacy, quiet, and sun and light exposure of neighboring properties.
- When conditions require a project to be different from its neighbors, provide a transition from existing to new development by careful placement and massing of buildings, well-designed planting patterns, and other means.
- Maintain vistas of surrounding hills and natural features.

**Preservation of Existing Natural Features.** Development proposals should demonstrate an effort to retain significant existing natural features characteristic of the community's landscape. Existing topography and land forms, drainage courses, vegetation, and views should be recorded in the Site Analysis and incorporated, to the maximum extent feasible, into the future development of the site.

#### Mature Trees

- All mature trees should be retained when feasible. This will require careful judgment weighing the value and hierarchy of all natural features, the size and species of the tree, and the program for the site.
- Existing oaks over 8 inches in diameter are considered significant resources to be preserved. See Appendix A, "Preservation of Mature Trees".

### Topography

- Demonstrate an effort to minimize grading and alteration of natural landforms. Grading will be allowed to the extent necessary to fit the buildings into the natural land forms.
- Minimize potential problems created by building in areas of excessive slope, soil with poor bearing capacity, slide potential, flood plain, or other hazards.
- Building pads are to be sited within zoned setbacks and should disturb natural contours as little as possible. Balancing of cut and fill areas is encouraged. See Appendix B, "Preservation of Mature Trees," for grading techniques necessary for the preservation of existing trees.

### Drainage

- Minimize potential surface drainage problems on neighboring properties, and provide adequate drainage on-site for each parcel.
- Natural drainage courses are to be preserved as closely as possible to their natural location and appearance. "Dry stream" effects which move the water over the property should be used instead of channeling or undergrounding methods, unless no other alternative to channeling exists.

### **Circulation and Parking**

- Provide a clearly identifiable circulation plan for automobiles, pedestrians, and service vehicles.
- Locate driveway access points on public streets that are safe and allow smooth traffic and pedestrian flow. Minimize the number of driveway openings to public streets.
- Off-street parking and service areas should be located behind buildings and landscaped to minimize visibility.
- Design pedestrian circulation to enable convenient access from parking to destinations.

### **Internal Site Design**

- Buildings and open spaces should be organized to take advantage of the spaces between buildings as opportunities for outdoor activities, as transitions between indoors and outdoors, and as potential points of "focus" on the site.
- Buildings and building groups should form compact clusters to economize in the use of land and create larger open spaces on the site.

- The site plan and planting should consider climatic conditions to provide shade from summer sun, natural ventilation, and other measures to maximize energy efficiency and human comfort.

### The Building–Street Edge

The *building-street edge* relationship is the most important consideration in planning a building site. In order to achieve the Town Center’s objective of creating a high-quality pedestrian environment, buildings should be located close to the front property line and sidewalk, with frontages designed to maximize pedestrian interest. The intent is to follow traditional patterns of town center layout, developing a consistency between the new and older parts of the Town Center.

#### The following building-street edges are desired:

- Continuous building edge with continuous porch along the sidewalk:

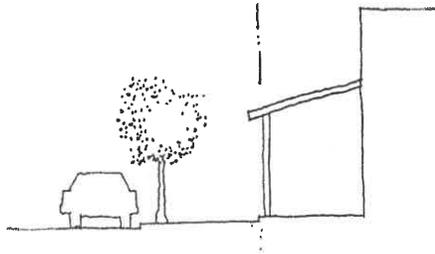

- Yard or courtyard fronting the street. A low wall or decorative fence may be used to define the front property line, or the yard may be open to the sidewalk with a pedestrian area between the sidewalk and building. The pedestrian area could develop into small courtyards with planting and benches:

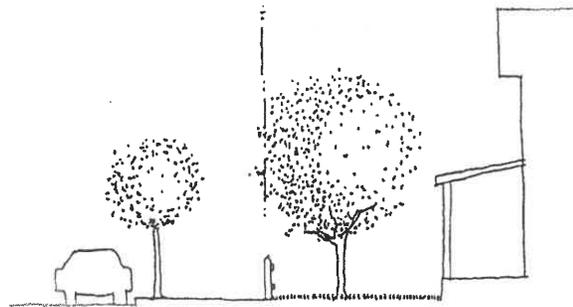

- Building entrance and building wall built up to the front property line:

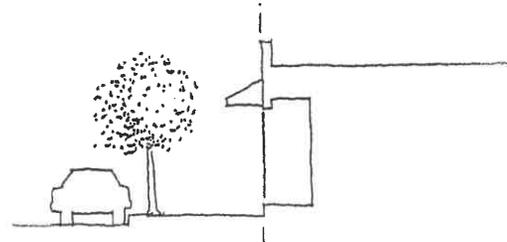

- Buildings should work within this vocabulary of street setback patterns. Building location and plan form should strive for a compatibility of setback pattern on each block.
- Every building should have a street-facing entrance. If a side or rear entrance is used, it should be accompanied by a street-facing entrance.
- Prohibit parking between the front elevation of the building and the street. Avoid placing of shrubs or other plants that create a visual barrier between the building and street.
- Building fronts should be parallel to the street. Avoid buildings whose primary mass is sited at an oblique angle to the street.
- In buildings with retail space at the ground level, the vertical elevation of the ground level should be located as close as possible to the vertical elevation of the public sidewalk in front of the building. Avoid an elevated ground level that separates the building from the sidewalk. (This guideline is not applicable where there is a change in existing grade between the building and sidewalk, nor is it applicable when it is necessary to elevate the building ground level above a flood plan elevation.)

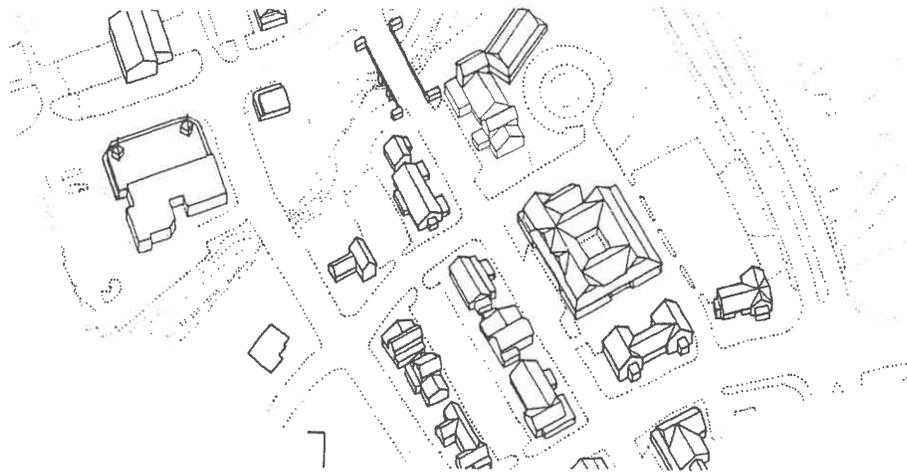

### **Yards and Courtyards**

The existing pattern of informal yard and courtyard spaces is an important part of the character of Clayton's Town Center that should be continued in new development. Yards and courtyards provide spaces for outdoor activities, shaded protection from the sun, and transitions from streets to the interiors of buildings.

The use of yards and courtyards to save existing trees and other natural features is encouraged.

**The following yard characteristics are desirable:**

Front Yards

- When a front yard is used in a commercial building, it should maintain a strong pedestrian connection between the building and street.
- Front yards defined with low stone walls or low picket fences at the front property line are encouraged. A pedestrian entry to the building from the front sidewalk through the yard should be provided.
- The use of low planting beds, trees, low shrubs, flowers, and small lawn areas is encouraged.
- Trees should be scaled and located to provide shade for pedestrians and to create a canopy for the front sidewalk space.

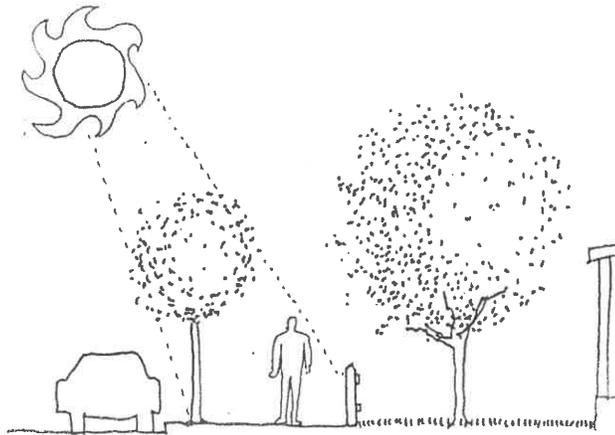

Courtyards

- Shared or individual courtyards are encouraged to provide pedestrian connections from rear parking areas to the street frontage and building entrances.
- Arbor structures with vines and flowers (in courtyards and between buildings) are a good way to link buildings and define exterior spaces with planted canopies while newly planted trees mature.

**Architectural Character**

**Building Form**

Size and Bulk

- New buildings in the Town Center should continue the predominant pattern of small buildings alternating with tree-canopied open spaces between them. This

pattern gives Clayton its unique spaciousness, allowing views through blocks and out to the foothill landscape.

- Building heights in the Town Center shall not exceed forty (40) feet.  
(Amended by Resolution No. 02-2007, dated 1/16/2007)
- In order to continue the Town Center's small building scale and fine grain character, building widths of 50 feet or less on principal streets are encouraged. Buildings over 50 feet in width are permitted if function necessitates, as in the case of a supermarket, but in such instances should be limited to 150 feet along a public street. Aggregation of several shop frontages into a single long building, as in the example of a typical shopping center, is not permitted.

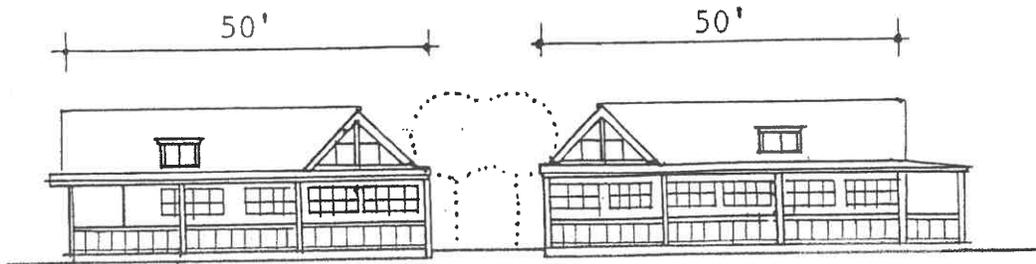

Revised January 2007

- When a building width must be greater than 50 feet, its elevation must be divided into smaller parts by one of the following methods:
  - *A change of plane in the form of a projection or recess.* A change of plane at the ground level should be accompanied by a change of plane at the eave or roof. The change of plane must be at least 5 feet in depth.

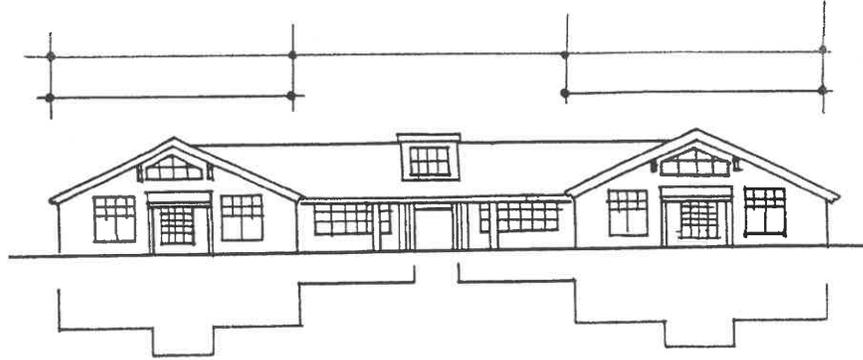

- *Clearly-articulated storefront bays of 30 feet width or less, with exact bay dimensions determined by carefully-studied proportions.*

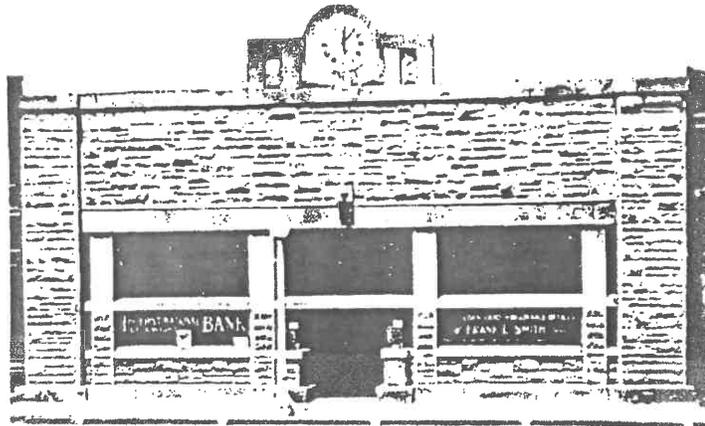

### Roof Forms

- Medium- to steep-gabled roof forms at pitches of 5:12 to 12:12 are encouraged, as is occasional use of dormers and shed roofs to add detail and scale. Roof pitches may be less in the case of large buildings, such as a supermarket.
- Avoid flat roofs that require built-up roofing materials, except in small areas and those that are not visible.
- Fascias, rakes and eaves. Gabled roofs should normally have a small overhang at both eaves and rakes. Eaves usually have a fascia board that covers the ends of the roof joists. Rakes have a trim board that covers the last roof joist. The overhanging rake may be supported by beam extensions and a variety of brackets to give additional detail where the wall meets the roof.

- Rooftop mechanical equipment should be avoided, except when no other feasible solution exists. When such equipment must be used, it should be minimized and screened from view.

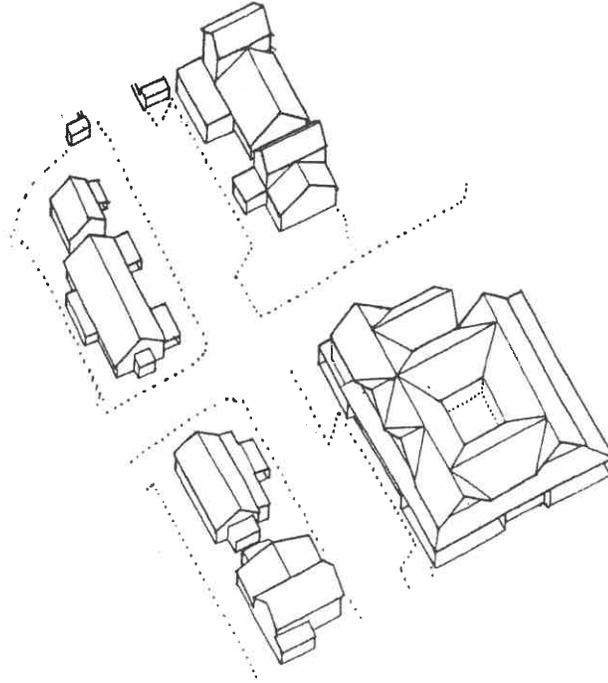

### Porches

- The frequent use of porches is an important characteristic of older buildings in the Town Center. A porch is a sheltered entrance and may be open or closed to make an outdoor room or other protected space. Porches are encouraged as a means of providing transitions between indoors and outdoors. They add visual interest to a building by providing shade, shadow, and a sense of depth. A porch can give a building its character and may often be the dominant element of a building elevation.

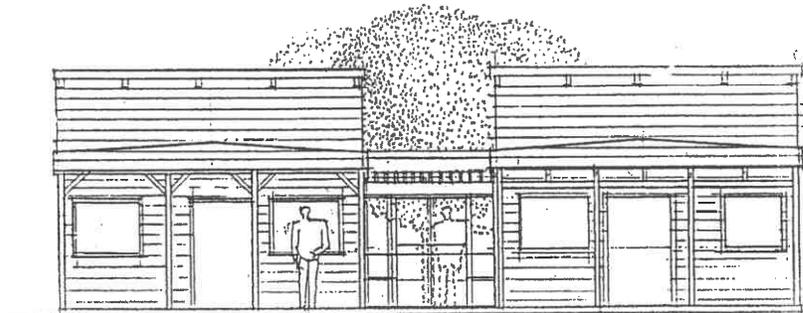

### Building Bases

- Buildings should meet the ground with a base relating to human size, or a detail that articulates the building from the ground plane. A base of ground-related material, such as exposed local stone facing, is encouraged.



### **Window Openings**

- Except at shopfront locations, the area of solid building wall should be greater than the area of window openings. Small window openings, or grouped windows, are preferred over larger openings.
- Large glazed areas should be avoided. When storefront windows are used, they should be divided by mullions into smaller elements, preferably less than 25 square feet each. Muntins are encouraged to further divide the window into smaller panes.
- Windows should be recessed to produce strong shadow lines.
- Two story buildings should avoid vertical windows over a single story in height. Window openings less than six feet in vertical dimension are preferred.

---

## Principles of Composition: Scale, Proportion, and Rhythm

### Scale

- Scale describes a relationship of building parts to human size, to other building parts, or to a group of buildings.
  - *Porches, dormers, recessed entrances, and eaves are encouraged to scale parts of the building to human size.*
  - *Along street frontages and in yards and courtyards, building elements at ground level should be kept to human size with relatively small parts. Exposed wood beams, columns, porches, exterior stairs, railings, trim, and other details are encouraged.*



- *Walkways and other paved areas near buildings should be divided into smaller parts. Paved areas should be interspersed with trees or other planting.*

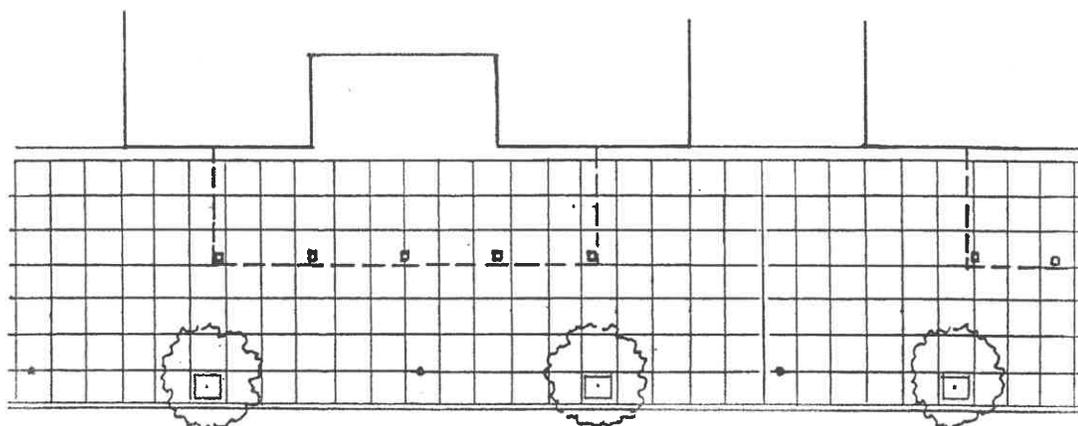

Proportion

- Proportion is tied to scale. It describes divisional relations of line, area, and volume.
  - *Building facades should have a carefully-studied, pleasing, proportional relationship of width to height.*
  - *Building parts, recesses, window and door openings, and details should relate to an overall system of proportions within the facade.*

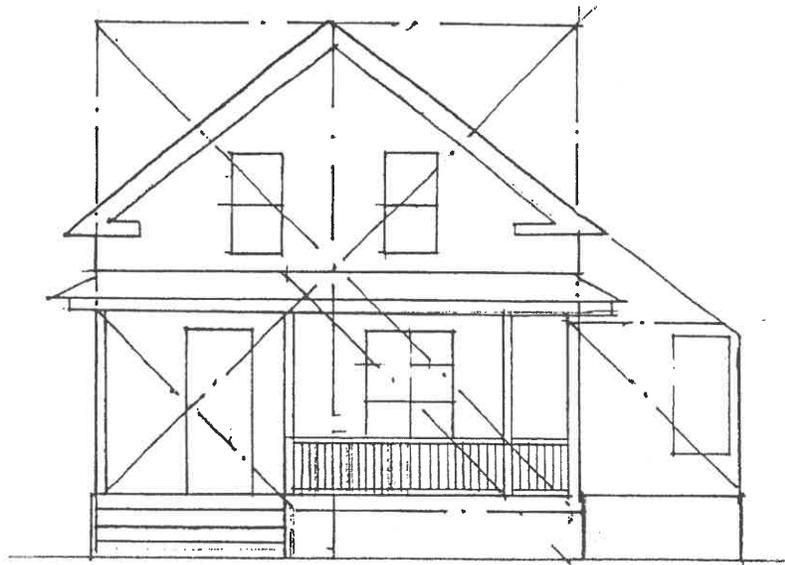

**Figure 4-5: Clayton-Pape House**

### Rhythm

- The use of rhythm as an ingredient of composition is tied to the careful use of repetitive spatial or structural parts to give an underlying order. This order can then be interrupted or varied. It is helpful to have some basic order of repetitive parts be apparent, though subtle, so that significant variations have importance.

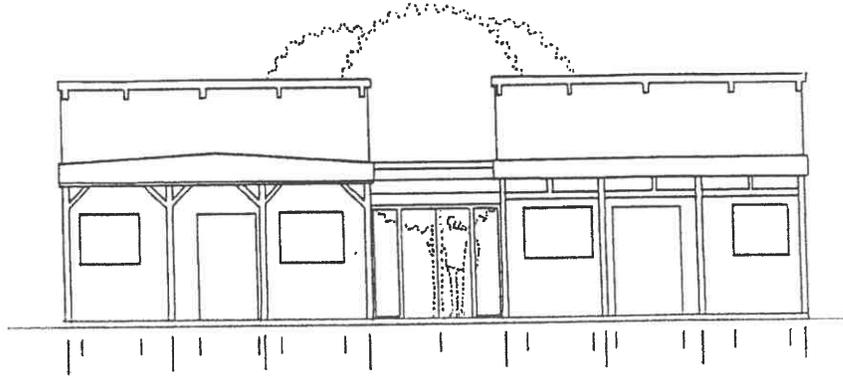

### Shade and Shadow

- Patterns of light and shadow give buildings depth and substance. Offsets, projections, overhangs, and recesses all may be used to produce effective shadow interest areas. Long unbroken expanses of wall or facade should be avoided along street frontages and corners.

### **Building Materials, Texture, and Color**

- Color selection should show evidence of coordination with the predominant use of color on neighboring buildings.
- Highly reflective or shiny materials should be avoided.

### The following building materials are encouraged:

- Exterior walls.
  - *Horizontal wood siding or wood shingles.*
  - *Walls built of or faced with stone.*
  - *Natural stone or brick facing (or approved equivalent) at foundations.*
- Roofs.
  - *Composition shingles (with heavy butts) in earth-tone colors.*
  - *Wood shingles, if treated for fire resistance.*
  - *Concrete shingles of earth-tone color.*
  - *Metal ribbed roofing (weathered metals and earth-tone colors preferred).*
  - *Avoid bright colors or highly reflective surfaces.*

- Details.
  - *Painted or stained timber beams and columns.*

The following building materials are acceptable:

- Walls.
  - *Cement plaster.*
  - *Brick or brick veneer.*
- Roofs.
  - *Clay roof tiles in earth-tone colors.*

The following building materials are not acceptable:

- Walls.
  - *Exposed concrete masonry, including split-face block.*
  - *Glass covering more than 30% of a building's exterior surface area.*
  - *High contrast or brightly colored exterior wall material.*
  - *Glass curtain walls.*
  - *Highly reflective or mirrored glass.*
- Roofs.
  - *High contrast or bright colors.*
  - *Galvanized sheet metal.*
  - *Built-up roofing, except for small areas.*

### **Pedestrian Walkways**

Standards for *public* sidewalks are listed under “Streetscape Design Standards.”

For *private* sidewalks and other paved pedestrian areas, the following materials are encouraged:

- Concrete with textured finish, especially exposed river gravel aggregate and wood board-stamped finishes.
- Tile, if it has non-slip surfaces and is earth-tone in color.
- Crushed granite and earth-tone gravel. Since these materials provide a barrier to handicapped persons, other means of access to the site and building must be provided when they are used.

The following materials are discouraged for private sidewalks and paved pedestrian areas:

- Asphalt is discouraged in areas adjacent to public streets and other high visibility areas. Asphalt is permitted in rear walkways, and paths to parking areas and service areas.
- Brightly-colored tiles.
- Any material with a hazardous surface when wet, or a material that would act as an impediment to a handicapped person.

### **Walls, Fences, and Accessory Structures**

Walls and fences should be designed to be compatible with the surrounding landscape and architectural character of the building.

#### Solid Walls

- Solid walls on primary elevations abutting public streets and sidewalks should be limited to 3 feet in height. Solid walls in other locations may be higher, but should be accompanied by a minimum 18-inch planted edge on each side, except on the interior of service areas.

#### Materials of fences and walls

- The following wall and fence materials are encouraged:
  - *native stone (used as structural wall, not as facing).*
  - *wood picket, rail, or split-rail fences.*

**Figure 4-6: Stone Wall**



**Figure 4-7: Traditional Wood Picket Fence**

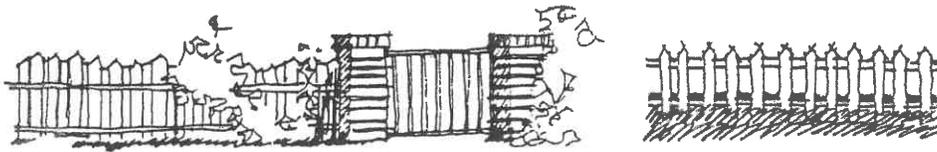

**Figure 4-8: Horizontal Rail Fencing Painted to Match Trim of the Main Structure**

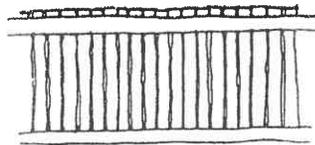

- The following wall and fence materials are acceptable:
  - *common brick.*
  - *cement plaster over wood frame or concrete masonry unit.*
  - *wood fences with historical or rural character.*
- The following fence and wall materials are not acceptable:
  - *chain link or open wire.*
  - *corrugated metal.*
  - *brightly colored plastic.*
  - *thin wood lath.*
  - *reed material.*
  - *precast concrete.*

Accessory Structures

- All accessory structures should be designed to reflect the scale and style of the architecture of principal buildings. Patio covers, greenhouses, storage spaces and other ancillary structures should be located and designed to respect the views and other special conditions of adjacent properties.

## Landscape Character



The landscape concept is to continue the spirit and atmosphere of the old Clayton Town Center, while allowing for some influence of contemporary planting ideas. The plants and landscape patterns recommended are conservative in nature, in order to maintain the continuity and tradition of the old part of the Town Center.

- Existing vegetation—trees, shrubs, ground cover—should be preserved when possible. Site plans must demonstrate that a diligent effort has been made to retain important existing natural features.
- Plant selection should recognize the importance of water conservation and emphasize plant species that require low water use.
  - *Large expanses of turf grasses are discouraged, except in parks or other active areas.*
- All site areas not used for buildings, pedestrian areas, parking, or other designated functions shall be planted. Decomposed granite is an acceptable substitute to ground cover. If used, it shall be wet-rolled in place, and used only on level ground.
  - *Bare ground, because it creates dust in summer and mud in winter, is not permitted.*
- All landscaped areas should have an underground irrigation system capable of sustaining good plant growth. Automatic systems are desirable.
- The following minimum area planting requirements shall be observed. Existing trees and shrubs that are retained may count toward planting requirements. New planting requirements may be further adjusted to reflect the size and density of existing trees and shrubs:

Revised January 2007

At least twenty (20) percent of each site of one acre or more must be landscaped open space. Sites less than one acre must provide at least ten (10) percent landscaped open space. (Amended by Resolution No. 02-2007, dated 1/16/2007)

- *Paved pedestrian areas, such as sidewalks, patios, and courtyards on the ground, may be counted toward this requirement.*
- *Internal parking lot landscaped areas may not be counted toward this requirement.*

All areas counted toward the landscaped open space requirement must provide the following: (Amended by Resolution No. 02-2007, dated 1/16/2007)

- *One tree per 300 square feet of the total required landscaped area. Trees shall be 15 gallon size, minimum.*
- *Shrubs, ground cover, decomposed granite, or paved pedestrian areas must cover all remaining required landscaped open space.*

Parking Areas (See “Parking Areas” guidelines for planting requirements.)

- **Planting Guidelines.** The following plant species are listed as examples, not requirements. See Appendix B, “Plant Selection Guide,” for a more extensive plant list.

Vines

- *Wisteria floribunda.*
- *Campsis chinensis* - Chinese Trumpet.
- *Parthenocissus tricuspidata* - Boston Ivy.

Ground Cover

- *Ivy.*
- *Wild strawberry.*
- *Vinca species.*

Shrubs, Small, up to 5 feet

- *Berberis thunbergii* - Barberry.
- *Mahonia japonica* - Holly Grape.
- *Nandina domestica* - Sacred Bamboo.
- *Hydrangea macrophylla.*
- *Chaenomeles lagenaria* - Flowering Quince.
- *Abelia grandiflora.*
- *Raphiolepis umbellata.*
- *Spiraea thunbergi.*

Revised January 2007

Shrubs, Taller

- *Pittosporum tobira*.
- *Eleagnus pungens* - Silverberry.
- *Forsythia suspensa*.
- *Fatsia japonica*.
- *Viburnum species*.
- *Magnolia liliflora*
- *Ilex cornuta* - Chinese Holly.
- *Aucuba japonica* - Gold Dust Plant.
- *Ligustrum texanum* - Texas Privet.
- *Prunus laurocerasus* - English Laurel.

Trees should be selected for size and form, in relation to other nearby trees, and buildings. Sunset's *Western Garden Book* provides the best source of information about plant characteristics.

Trees, Small

- *Lagerstroemia indica* - crepe myrtle.
- *Trachycarpus fortunei* - Windmill Palm.
- *Acer palmatum* - Japanese Maple.
- *Albizia julibrissin* - Silk Tree.
- *Cercis sp.* - Redbud.
- *Crataegus sp.* - Hawthorn.
- *Arbutus unedo* - Strawberry Tree.

Trees, Medium

- *Eriobotrya sp.* - Loquat.
- *Eucalyptus sp.*
- *Hymenosporum flavum*.
- *Leptospermum laevigatum* - Tea Tree.
- *Ligustrum lucidum* - Tree Privet.
- *Magnolia sp.*
- *Maytenus boaria* - Mayten.

Figure 4-9 following this page presents the Landscape Plan for the Town Center.

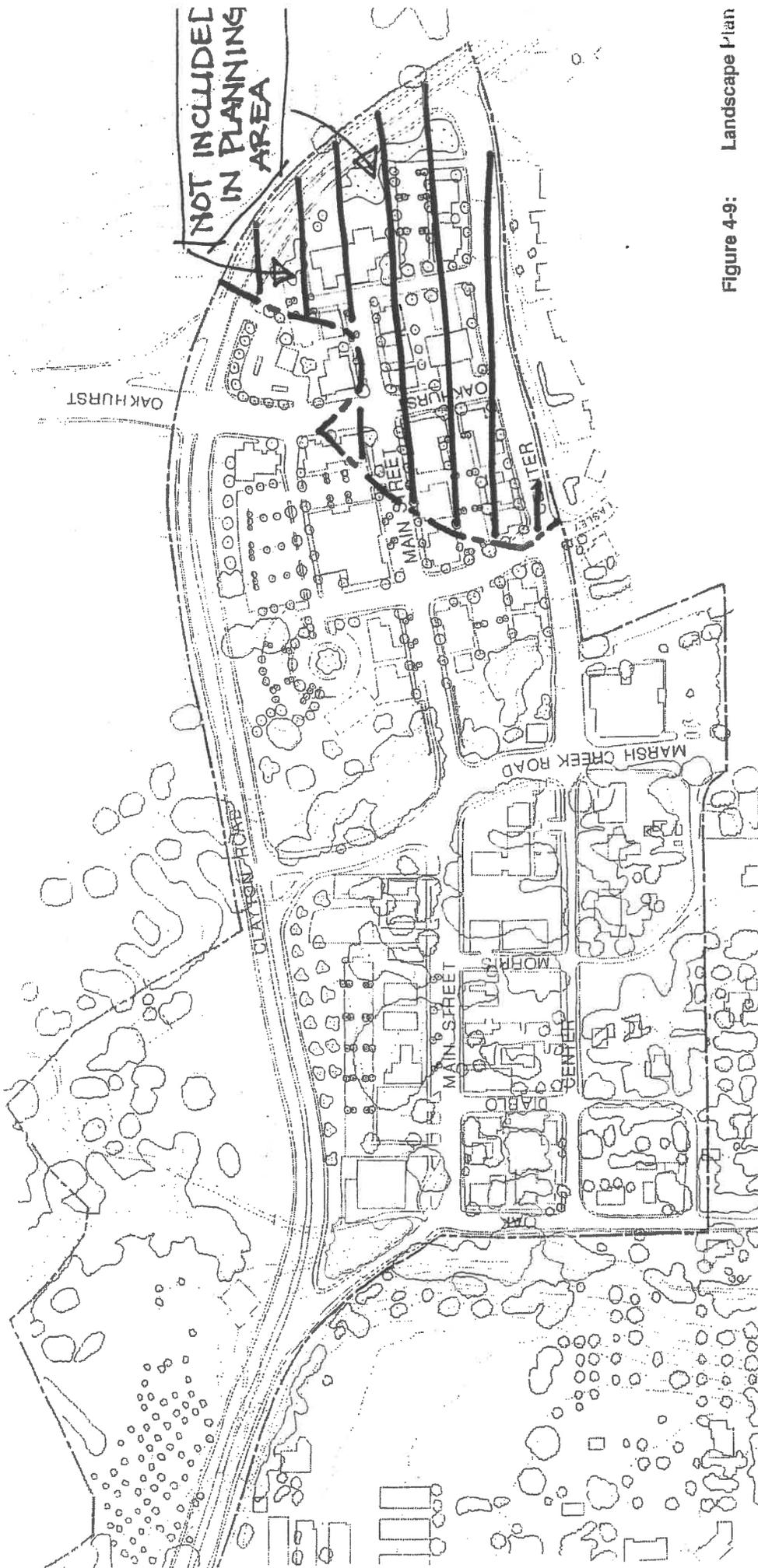

NOT INCLUDED  
IN PLANNING  
AREA

Figure 4-9: Landscape Plan

Note: This map is not dimensionally accurate and can not be relied upon for measurements of distance or land area.

Nephthali H. Knox & Associates, Inc.  
Baron-Arciman Associates, Inc.  
Gerald Gust, AIA, & Daniel Hillmer, AIA, Urban Design  
Munda & Associates  
Garrett Echlo, ASLA



- EXISTING TREES
- PROPOSED TREES
  - SINGLE SPECIMENS
  - TRIPLE SPECIMENS
  - MULTIPLE GROUPS

**TOWN CENTER  
SPECIFIC PLAN  
AMENDED BY  
RN 65-98, DATED 2-1-98**  
City of Clayton, California

## Preservation of Historic Buildings



Clayton Town Center's history is recorded in the few remaining structures built before the turn of the century. New development should recognize, respect, preserve, and be compatible with the historic buildings and mature plantings in the existing Town Center.

A building exhibiting historic character from the period in which it was built can substantially contribute to the character of a new development.

### **Historic buildings will fall into one of the following categories:**

- An existing structure may already be a Designated Historic Site (The DeMartini Winery) or may be part of a Designated Historic District.
- In other cases a site may not be designated, yet it may have historic or architectural significance to Clayton, Contra Costa County, or California. If a site is suspected of being historically significant, the following steps should be taken:
  - *Contact Planning staff of the Town of Clayton for assistance.*
  - *Research to establish the validity of the site's historic role.*
  - *Nominate the site for historic registration if it so merits.*
  - *Incorporate existing buildings on the site into new improvements and development.*
- The third possibility is that a building or site has a distinct historic character but does not necessarily qualify as a Designated Historic Site.

### **Guidelines for Design Review**

- Alterations and additions to buildings that are Designated Historic Sites or located in a Designated Historic District should follow the Secretary of the Interior's "Standards for Rehabilitation and Guidelines for Rehabilitating Historic Buildings" published by the U.S. Department of the Interior. A copy of the "Standards" is located at the City offices.
- The State of California Historic Building Code shall be used in place of local building codes in the case of qualifying historic structures.
- New buildings which are built on the same site as, or adjacent to, buildings of historic character, should be designed to be respectful of the older buildings. Without mimicking the older buildings, new structures should consider the compatibility of details, materials, textures, colors, and landscape features.
- New buildings or building additions must demonstrate, to the satisfaction of the Planning Commission, that impacts on adjacent historic structures have been mitigated.

### **Relationship of New to Existing Development**

All development proposals should show evidence of harmony with neighboring properties through their site planning, arrangement of building forms, and landscape design.

The degree to which neighboring properties and buildings must be considered in the design of a new project will depend on the value, architectural quality, and estimated tenure of improvements on the neighboring property, as well as the particular requirements of the new project.

Projects presented to the Planning Commission should show important features of adjacent sites. Existing features should be shown in sufficient detail to enable evaluation of the relationship of the proposed development to its context. Eye level perspective sketches of the proposed project and its immediate neighbors, as seen from the street, sidewalk, or other public place are encouraged.

### **Site Planning Considerations**

- The site organization should compliment the arrangement of buildings, open spaces, and landscape patterns on adjacent properties. When possible, buildings should be located for mutual advantage of shared open spaces, sunlight, circulation, parking, and views. Landscape features on adjacent properties should be compatible.
- When feasible, new development should be linked to adjacent properties by common circulation areas for people and cars. The method of shared circulation, parking, or walkways will vary depending on the specific site conditions. When no

development exists on adjacent properties, give consideration to how the sites can develop common circulation linkages in the future.

### **Architectural Relationships between New and Existing Buildings**

- In both the existing Town Center and its new expansion area, new buildings and additions should be designed to respect the scale, in height and width, of surrounding buildings.
- Buildings of different size, form and materials can relate to each other through the use of common proportions, window and story heights, belt courses, porches, building bases, and other elements in a pattern that relates to neighboring buildings.



### **Parking Areas**

Parking in the Town Center includes both the on-street and off-street supply. The following guidelines apply:

#### **On-street parking:**

- Diagonal parking is located on both sides of Main Street.
- Parallel parking is found on most other streets.

#### **Off-street parking:**

- Parking should not be located in required setback areas.
- Parking should not be located between a building and the street.
- Locate parking to the rear of the property. A less desirable solution, but acceptable when special conditions exist, is to locate the parking to the side of the buildings.
- Locate access for service vehicles, trash collection, and storage areas on minor streets and parking lots when possible.
- Existing mature trees shall be retained and integrated into the layout of parking areas.

- Curb cuts for driveways should be limited to a minimum number. Except in special cases, only one curb cut on a public street shall be permitted for each property.

Parking lot perimeters

- *Off-street parking lots should be visually screened from street view by planting or a combination of planting and low walls. A continuous screen at least 30 inches high should be formed by the wall or planting. If shrubs are used to create this screen, the shrubs should be a minimum of 30 inches in height after two years growth. Space shrubs in massed plantings so that branches intertwine after two years average growth. Open wood fences may be used, but only in combination with vegetation to fully screen the parking area from view.*
  - *Planted perimeter areas must be at least 5 feet deep along public streets and interior property lines. Provide at least one tree (minimum 15 gallon size) per 150 square feet of perimeter area between the property line edge and the parking lot.*
- Parking lots must be set back at least 5 feet from the face of a building.

Internal parking lot planting

- *Parking lots should include internal planting to develop tree canopies that soften the visual impact of the lots and provide relief from heat build-up. For all parking lots greater than 6,000 square feet, an internal area at least 10 percent of the total parking area should be planted with a combination of trees and shrubs. Tree spacing should be such that every designated parking space is within 30 feet of the trunk of a tree (minimum 15 gallon size).*

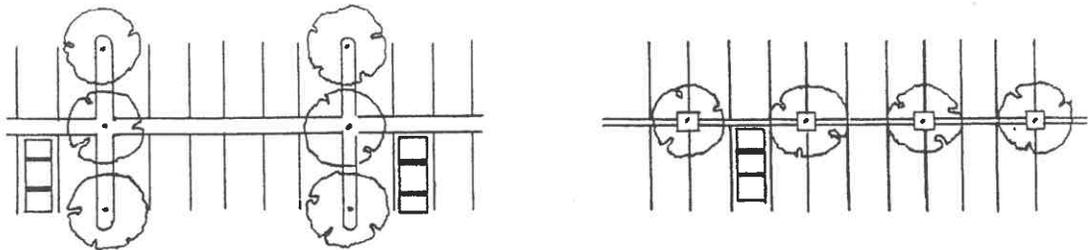

## Signs

### General Design Criteria

- All signs should be a minimum size and height to adequately identify a business.
- Signage design should be carefully integrated with site and building design to create a unified appearance for the total property.
- Signs should be carefully located for safety so as not to block driveway views of oncoming traffic.
- Illumination should be projected onto the sign face. The light source should be fully shielded from view. Internally illuminated plastic signs are prohibited.
- Color of all signs and sign components should be limited to 3 in addition to black and white.
- Typefaces should be chosen for their simplicity and clarity. Signs on older buildings are encouraged to use a typeface which was used in the period the building was built.
- Sign posts and other structural elements should be made of wood or metal with a white, earth-tone, black, or natural stain finish. Reflective or bright colors are not permitted.
- No sign, other than a sign installed by a public agency, should be placed in the public right-of-way on sidewalks or streets. All such signs should clear pedestrian spaces with a minimum headroom of 8 feet.
- No signs are allowed above the highest portion of the building.
- A master signage program shall be designed for projects containing three or more business establishments.

### Recommended Sign Types. The following types of signs are recommended:

- **Awning Valance:** A sign or graphic attached to or printed on an awning's valance.
- **Monument:** A sign supported by one or more uprights or braces on the ground.
- **Hanging:** A sign attached to and located below any eave, canopy or awning.
- **Kiosk:** A small freestanding structure which has one or more surfaces.
- **Projecting:** Any sign which projects from and is supported by a wall of a building with the display of the sign perpendicular to the building wall.
- **Wall:** A sign affixed directly to an exterior wall or fence.
- **Window:** A sign affixed to or behind a window.
- **Single Pole Hanging Sign:** A sign which is suspended from a horizontal arm which is attached to a pole.

**Figure 4-10: Sign Types**

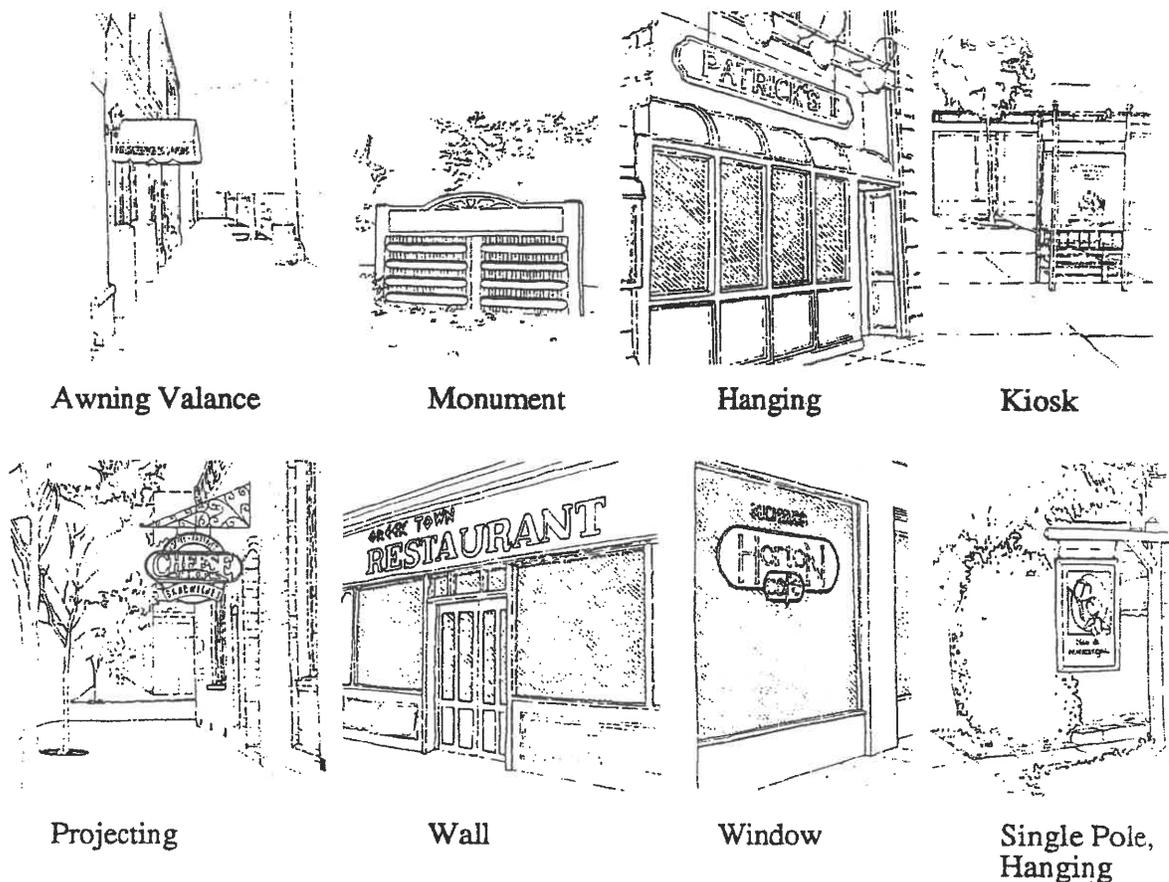

**Sign Area And Number**

Maximum letter and symbol height

- Eight inches on all sign types except wall and hanging signs, which may be 12 inches in height.
- Sign areas are limited in size and vary with sign types.
- To calculate the size of a sign, measure:
  - *The area of the box or outline which contains the sign, or*
  - *In the case of unboxed letters or symbols, the area of the smallest rectangle which would enclose all of the letters or symbols.*

- Only one face of a double-faced sign with parallel opposing faces, and bearing identical copy, shall be used in calculating sign area. Signing and illumination shall be limited to no more than two opposing faces.

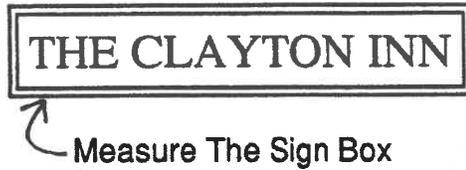

**Fig. 4-11: Measuring a Boxed Sign**



**Fig. 4-12: Measuring an Unboxed Sign**

Sign areas are limited in size and vary with sign types. Maximum permitted areas are:

- Awning Valance: 3 square feet.
- Monument: 12 square feet.
- Hanging and Wall: 12 square feet.
- Kiosk: 24 square feet (total of all faces).
- Projecting: 8 square feet.
- Window: 6 square feet (no larger than 25% of the window on which it is displayed).
- Single Pole, Hanging: 6 square feet.

Sign size may be considered for large buildings on a case-by case basis.

#### Properties with more than one tenant

The following number and area of signs are permitted:

- One sign to identify the complex, not to exceed the size limits previously listed, and
- One sign for each individual tenant, to a maximum of 10 square feet, but not to exceed the limits of any sign type listed previously, and
- Up to two building directory signs located at principal pedestrian entrances, each not to exceed 8 square feet.

#### Sign height limits

- Awning Valance and Projecting: 10 feet (all dimensions are above grade).
- Monument: 3 feet.
- Hanging and Wall: 15 feet.
- Window: 7 feet.
- Kiosk and Single Pole Hanging: 7 feet.

### Residential Signs

Multi-family residential properties of 12 or more units may have one sign of 10 square feet or less. Only monument and single pole hanging signs are permitted for residential use.

### Addresses

Address numerals are not counted toward signage area, nor are traffic direction or public information signs.

### **Prohibited Signs**

The following signs are prohibited:

- Roof and parapet signs.
- Internally illuminated plastic signs. All plastic signs are strongly discouraged.
- Back-lighted signs which appear to be internally illuminated.
- Pole signs. (Only Single Pole Hanging signs are permitted.)
- Portable or mobile signs.
- Signs which cover or interrupt architectural features.
- Off-site signs.

### **Site Lighting**

#### **General Requirements**

- Limit the amount and intensity of lighting to that necessary for safety, security and to compliment architectural character. Lighting is not permitted which would spill onto—or interfere with the character of—the surrounding neighborhood.
- Lighting which is visible from adjacent properties or roads must be indirect or incorporate full shield cut-offs.
- Service area lighting should be designed to avoid spill-over into adjacent areas.

#### **Parking Area Lighting**

- For commercial parking areas, overhead lighting should be mounted at a maximum height of 15 feet above the paved surface.
- For residential parking areas, overhead lighting should be mounted at a maximum height of 10 feet. The placement of lighting in residential parking areas should avoid interference with bedroom windows.

### **Walkway, Garden, and Pedestrian Area Lighting**

- Overhead fixtures used for pedestrian areas should be limited to a height of 10 feet, with a minimum of 8 feet vertical clearance.
- Along walkways, low-level lighting fixtures mounted on short posts are encouraged. Shatterproof coverings are recommended. Posts should be located to avoid hazards for pedestrians or vehicles.

### **Building Equipment And Services**

Carefully locate and design building equipment and services to minimize their visual impact on public streets and neighboring properties.

Trash containers and outdoor storage areas should be screened from view from public streets, pedestrian areas, and neighboring properties. The screen for trash containers should be designed to be compatible with the architectural character of the development and be of durable materials.

Locate utility meters and other mechanical and electrical equipment in service, loading, or screened areas. Exterior surface-mounted utility conduit and boxes should be kept to a minimum. Where they do exist, they should be designed, painted, or screened to blend in with the design of the building to which they are attached.

Mechanical equipment, solar collectors, satellite dishes, communication devices, and other equipment should be concealed from view from public streets, adjacent properties, and pedestrian-oriented areas to the extent technically practical.

- Where solar panels are attached to buildings they should be integrated into the architectural design of the building. Solar panels which are not attached to buildings should be integrated into the landscape design by using berms, natural slopes, or similar devices. All plumbing and storage tanks associated with solar panels should be concealed from view from streets, sidewalks, the trail system, and neighboring properties.

Roof-mounted equipment is discouraged. When such equipment is necessary, it should be screened from view from roads, the trail system, adjacent properties, and pedestrian areas. Special attention should be given to changes in elevation which may provide a view down to a roof. In this case, enclose the equipment in a screened shelter or design the layout of exposed equipment in an orderly fashion. Paint the equipment in a color similar to the rest of the roof.

Screening devices (roof-top and at ground level) should consider the following elements:

- Architectural screens should be an extension of the development's architectural character.
- Screen walls should be constructed of low maintenance and durable materials which are consistent with the main building's materials.
- Landscaping should be used in conjunction with building materials to complement ground level screening devices.

### Streetscape Design Guidelines

The following guidelines apply to *public* street and sidewalk spaces.

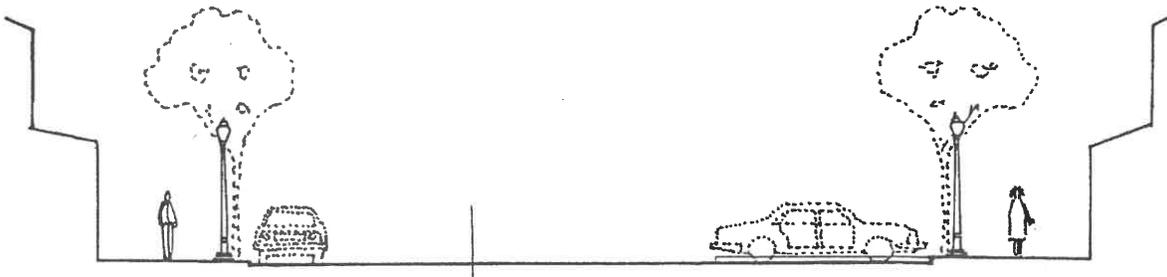

**Figure 4-13: Possible Main Street Cross-Section With Parallel Parking One Side**

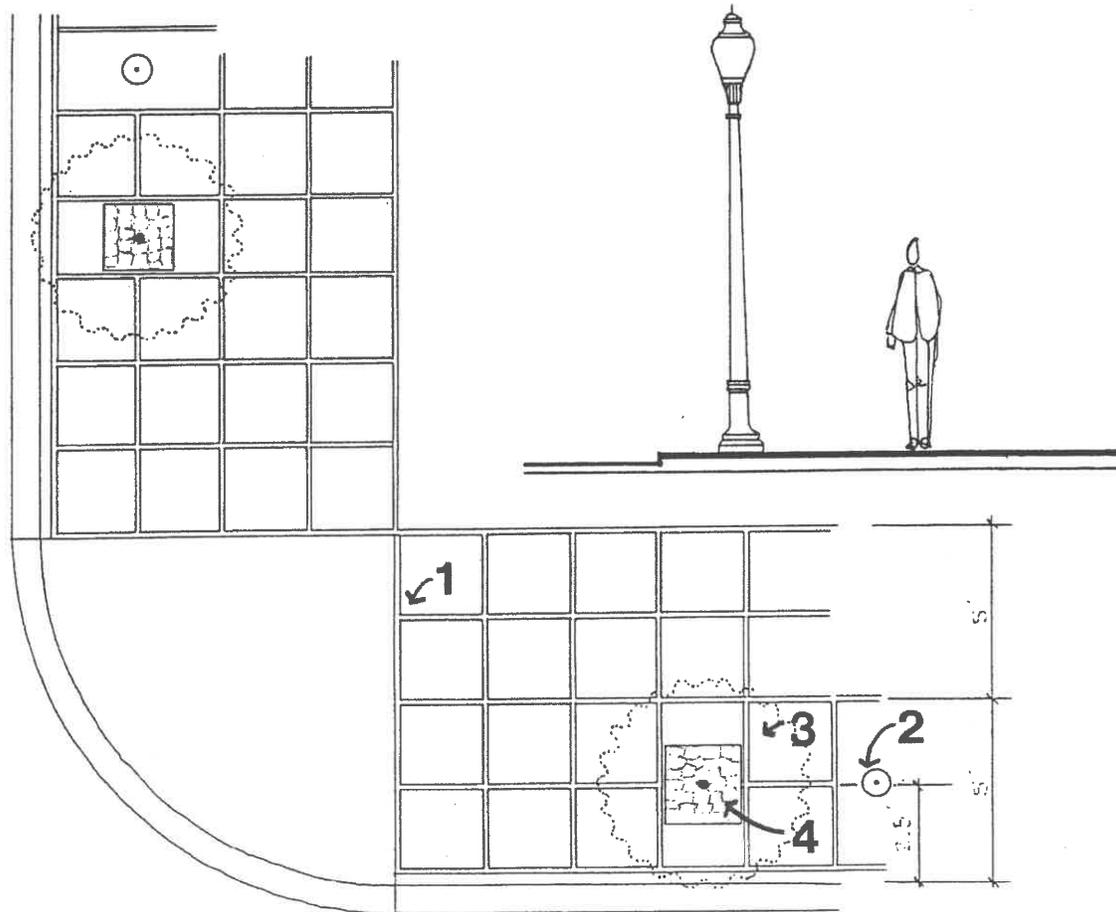

**Figure 4-14: Main Street–Corner With Streetscape Elements**

**1. Concrete sidewalk and vertical curb**

- Exposed aggregate (river gravel) finish. Divide into modules (module size variable) with 2" x 4" wood dividers pressure-treated for ground contact. Natural green color.
- Process for exposed aggregate: Place concrete, strike off, float and trowel. When set sufficiently for walking, expose surface by brooming and hosing until aggregate is uniformly exposed.
- Curb: Poured-in-place vertical curb, standard finish (not exposed aggregate). Granite curbs or an acceptable alternative may be substituted for concrete curbs along Main Street, in lengths of at least a full block.

## 2. Street light fixture

- Use the City's existing historical street light fixtures in the old Town Center. Refinish and adapt as necessary.
- In the new area of the Town Center, and as a supplement to the City's existing stock of historical fixtures, use the following:
- Western Lighting Standards "San Diego" series (or equivalent). All cast aluminum 12 foot high pole with 175-watt metal halide light source. Pole color – black. Clear polycarbonate globe.

## 3. Street trees

### Main Street

- *Quercus agrifolia* - Live Oak, or *Quercus ilex* - Holly Oak.
- *Aesculus californica* - Buckeye.
- *Schinus* - Pepper Tree.

### Marsh Creek Road

- *Ligustrum japonicum* - Japanese Privet.
- *Magnolia grandiflora* - Evergreen Magnolia.
- *Maytenus boaria* - Mayten Tree.

### Oakhurst Boulevard

- *Pinus halepensis* - Aleppo Pine, and *Pinus Pinea* - Italian Stone Pine.
- Selected Eucalyptus.
- *Betula papyrifera* - Canoe Birch.

## 4. Street tree base

- Large cobblestones laid in sand with top elevation matching the adjacent sidewalk. The cobblestone area should not exceed 3 ft. x 3 ft. A minimum of 6 ft. of the sidewalk width must be concrete finish, unobstructed by the cobblestone tree base.

## 5. Benches

- "Warwick" model manufactured by Green Brothers Limited, (or equivalent), available through Lister Teak, Inc., Exton, Pennsylvania, and other distributors. This is a traditional English style park bench. Available in 6 ft. and 8 ft. lengths.



---

**GUIDELINES FOR SPECIAL AREAS AND SITES**

Special design considerations and illustrative sketches for key areas of the Town Center are described in this section.

**Figure 4-15: The New City Hall Site**

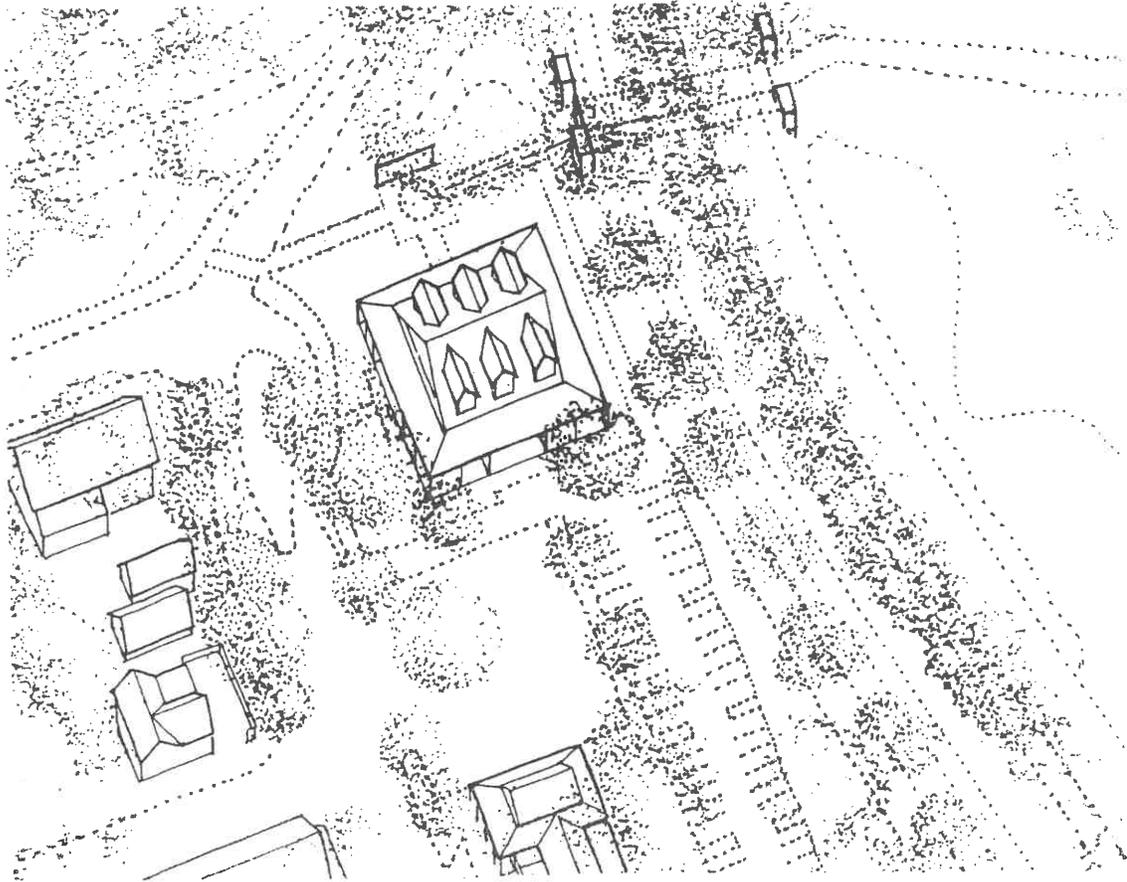

Locating the new City Hall at the west end of Main Street offers the following advantages and opportunities:

The City Hall will be highly visible from Clayton Road and will become the Town Center's most important building.

The site provides a direct pedestrian connection to the Historic and Cultural Center through the pedestrian underpass. This linkage should be incorporated into the design of the City Hall and its grounds, and should be extended to the Mitchell Creek/Oak Street Park as well.

City Hall and public parking for the west end of the Town Center is located east of the building, between Clayton Road and the Main Street commercial buildings.

**Figure 4-16: Main Street West of Marsh Creek Road**

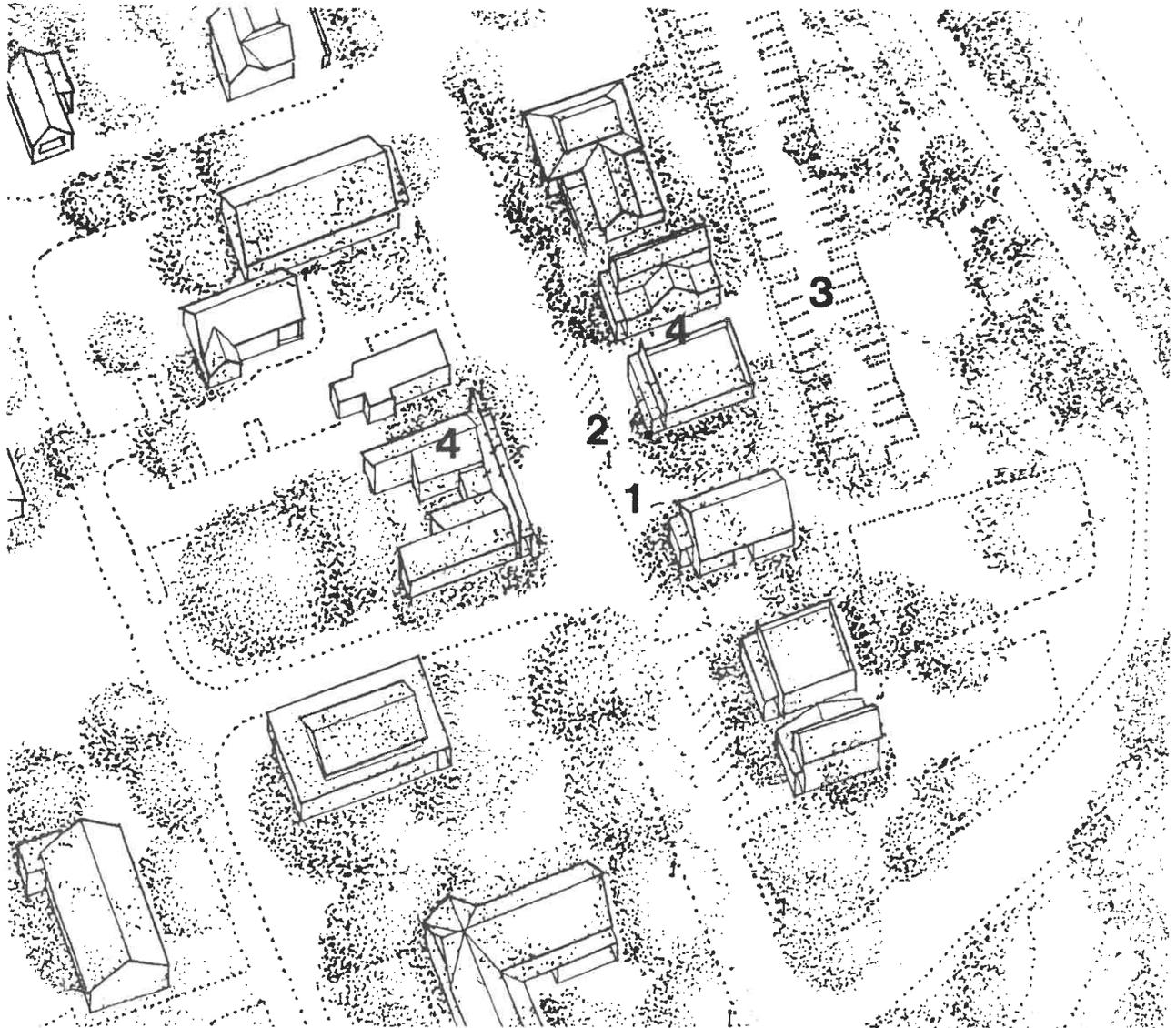

1. New street, sidewalk, and street lighting improvements.
2. New diagonal parking.
3. New public parking, south of Clayton Road. One or more access drives from Main Street are needed, their location subject to negotiation between the City and the property owners.
4. New private “infill” development compatible with neighboring buildings.

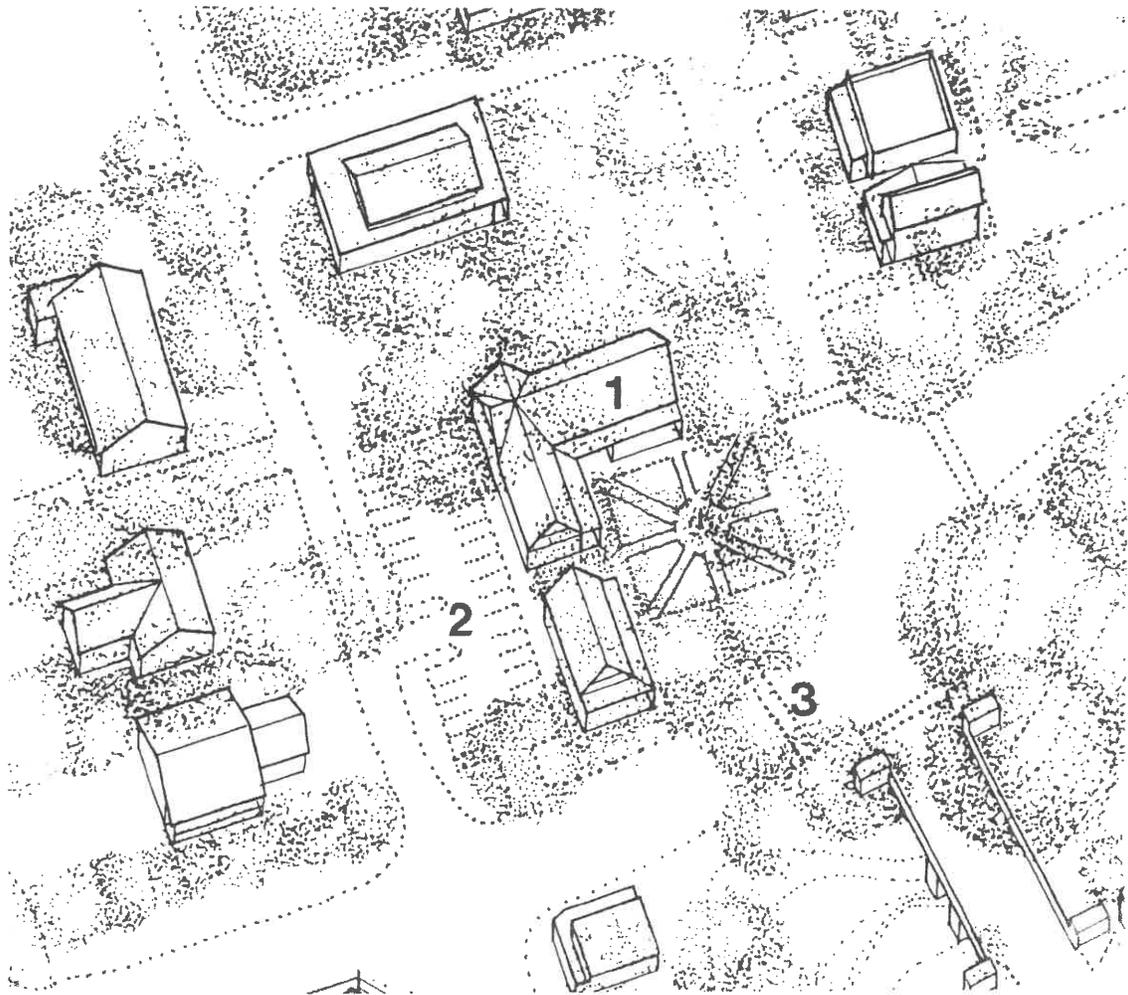
**Figure 4-17: "The Grove"**

The Clayton Town Center needs a strong focus and a gathering place. Historically, The Grove served this function for special events. The canopy of eucalyptus trees and The Grove's corner location make it the "natural center" of town. Away from the corner, there is potential for a commercial development that will preserve the natural setting while enlivening the corner for informal gatherings and public events. The Plaza in Mill Valley, with its cafe, is an example of a similar space. Design considerations include:

1. Siting of one- or two-story buildings to frame an open space facing Main Street and Marsh Creek Road. Incorporate as many existing trees as possible into the plan and add new planting to reinforce and to succeed the existing tree canopy.
2. Locate parking south of the buildings, with access from Center Street, to emphasize the pedestrian nature of the site along Main Street and Marsh Creek Road.
3. Design a strong pedestrian connection across the Marsh Creek Road/Main Street intersection.

(Amended by Resolution 65-98, dated 12/1/98)

**THIS PAGE INTENTIONALLY LEFT BLANK**

FIGURE 4-18: MOUNT DIABLO CREEK AND CREEKSIDE PARK

DELETED BY RESOLUTION 65-98, DATED 12/1/98

## **DESIGN REVIEW SUBMITTAL REQUIREMENTS**

This section lists submittal requirements for all projects subject to Design Review. Ten copies of all drawings must be submitted. All copies must be folded to fit an 9" x 13" envelope, unless they are so thick they can only be rolled up.

Submittals are to be as clear as possible and follow accepted conventions of drawing—*i.e.*, all drawings clearly labeled, dated, scales shown, north arrow on plans, clear and readable line work. Responsible persons should be named.

Proposals should not be presented open-ended with expectations that the City staff or Planning Commission will make decisions.

Additional information, drawings, or other materials necessary to describe the project may be requested by the City, depending on the nature of the project or site. Also, depending on the project's nature, not all of the listed requirements may be needed. The applicant should discuss proposed modifications with the Planning staff.

The applicant may include additional information or materials such as sketches, models or photos if they help explain the proposal. *Photos of the site and surrounding properties are always required.*

### **Preliminary Review**

Developers that elect the optional step of Preliminary Review may submit drawings or other materials appropriate to the nature of the project and extent of planning studies completed. In most cases, site design, location of buildings, grading, basic form and height of buildings, and landscape concepts will be important. Building elevations, perspectives, and other information may be presented, but kept in preliminary form.

### **Submittal Requirements**

#### **Site Analysis (Analysis of existing site conditions)**

To enable evaluation of development proposals in relationship to existing conditions on the site, the following information must be presented on one or more drawings, accompanied by photographs and, if needed, written description.

Basic site information (to be located on the drawing): Site boundaries with dimensions; building setback lines and easements; existing streets, sidewalks and public right-of-ways; existing structures (including historic structures) and other built improvements.

Existing natural features (to be located on the drawing)

- Trees 6 inches or more in trunk diameter. Note trunk size and species.
- Topography. Existing contours at 2-foot intervals with areas of slope over 25% highlighted.
- Patterns of surface drainage, including location of dry and running streams, washes, and natural swales.
- Location of flood zone.
- Locate other significant natural features which are either site amenities or potential hazards in development.
- Designated trails.

Cultural resources assessment. A cultural resources assessment shall be conducted by a qualified expert (approved by the Community Development Director) prior to development of every developed parcel which contains over 10,000 square feet of undeveloped area, as well as every vacant parcel. (Added by Resolution No. 02-2007, dated 1/16/2007)

Photographs of the site and neighboring environment. Provide photographs of the existing site and site conditions on adjacent properties within 400 feet of all site boundaries (including buildings on adjacent sites). Include photos of views to and outlooks from the site. Clearly label each photograph.

Written summary. A brief written synopsis should summarize:

- Existing site amenities and assets.
- Site areas in need of special consideration or to be avoided due to such problems as poor soil, drainage, steep slope, high water table, flood plain location.
- This synopsis may be noted on the Site Analysis drawing.

## Site Plan

Boundaries and public improvements

- Site boundaries, building setback lines, public streets and sidewalks (as proposed—include widths), other proposed public improvements (curbs, gutters, curb cuts).
- Include dimensions.

Streets, sidewalks, and parking areas within the site

- Include dimensions of driveways, parking areas, and sidewalks.
- Show location and label materials of areas of special paving such as walkways, courtyards, patios, and porches.
- For parking areas show layout of spaces, areas of landscaping, dimensions of spaces and aisles, and arrows indicating direction of flow. Number the parking spaces. Indicate compact and handicapped spaces.

Revised January 2007

### Structures

- Location and dimensions with respect to lot lines.
- Include fences, walls, and accessory buildings proposed. Give heights of fences and walls.

Show location of dumpsters and loading areas.

Grading and Drainage may, at the option of the applicant, be drawn on a separate plan which should include:

- Existing and proposed contours at 2 foot intervals.
- Finished floor elevations of proposed structures.
- Indication of all water courses, with spot elevations of high and low points.
- Area and depth of cuts. Location and height of fills.
- Show retaining walls and adjacent spot elevations.

### **Landscape Plan**

Show at same scale as Site Plan. In the case of small projects, the Landscape Plan may be combined with the Site Plan.

Existing trees 6 inches or more in diameter with their proposed disposition (to be retained or removed). Give species and trunk diameter of each.

Proposed location, species (give common and Latin name), and size (gallon or box size, at planting) of all new plant materials.

- Use symbols and a legend as necessary. Show all plant materials to scale.
- Ground cover may be indicated in mass.

Describe method of irrigation. Describe drainage provisions for oak trees.

Describe means of erosion control, if applicable.

### **Building Floor Plans**

**Building Elevations** (show all elevations)

- Note all finish materials on drawings.
- Provide color samples on one color board.
- Dimension building heights from finish grade.
- Include exterior walls and fences with heights dimensioned.
- Show locations and sizes of building-mounted signs on building elevations.
- Show location of mechanical equipment, roof equipment, electrical transformers, and solar panels on building elevations. Show means of screening roof equipment.

Revised January 2007

### **Sections**

One sectional drawing is suggested at a suitable scale to show relationship of buildings to the site, the public street, and the parking area. This item is required on sites with slopes over 25%, but otherwise is optional.

### **Signs**

Provide a scaled drawing of each proposed sign with exterior dimensions and mounting height called out. Give total area of each.

- Draw or provide sample of letters and logos, and the full message to appear on the sign.
- Describe materials and colors of background and letters.
- Give means and magnitude of illumination.

### **Lighting**

Provide a site lighting plan with location, type, fixture height, power rating, and shielding methods indicated. Include security lighting. Show elevation drawing or manufacturer's photo of each fixture, including its material and color.

**Statistical Summary.** Provide a written summary of—

- Site areas. Total area of site, area-covered by buildings, area covered by parking lots and driveways, and net area of site landscaping—all in square feet.
- Buildings. Total enclosed building area. If a residential project, give number of units and development density (units/acre).
- Number of parking spaces required and proposed.

This information may be noted on the Site Plan drawing.

# CHAPTER 5. CIRCULATION

## **DESCRIPTION OF EXISTING CONDITIONS**

### **Regional and Local Roadways**

At present, the only access into the Clayton Town Center is from the west and north via Clayton Road, and from the south and east via Marsh Creek Road. The two roads meet in the Town Center, where they become Main Street for three blocks between Oak and Marsh Creek Roads. Clayton Road—which will be a four-lane arterial by 1990—provides access to Central and East Contra Costa County by connecting to Ygnacio Valley Boulevard/Kirker Pass Road—a regional north-south arterial. Marsh Creek Road provides access to residences and farms to the east, en route to Brentwood and San Joaquin County.

The streets within the Clayton Town Center form a grid extending two blocks south from Main Street to High Street, and three blocks east from Oak Street to Marsh Creek Road. The Town Center streets are paved except for High Street and portions of Diablo and Morris south of Center. Marsh Creek Road provides arterial access to a number of curvilinear local streets to the south and east. Oak Street provides collector access to some of these areas, and Center Street provides access to Easley Drive to the east.

### **Intersection Levels of Service in 1988**

The Level of Service (LOS) scale describes intersection operating conditions during a peak hour. For this report, a Level of Service method based on volume-to-capacity (V/C) ratios is used.<sup>1</sup>

Figure 5-1, on the following page, describes each level of service in qualitative terms.

Existing intersection Levels of Service were not calculated for this study; rather, counts and levels of service from recent traffic studies in the area were used, as shown in Figure 5-2 on page 78.<sup>2</sup>

---

<sup>1</sup> The calculation method used in this report is the one most widely used for planning purposes. It is generally referred to as the Circular 212 Planning Method. For a description of the method, see the National Transportation Research Board, *Interim Materials on Highway Capacity*, Transportation Research Circular 212, January 1980.

<sup>2</sup> Two traffic studies in the vicinity of downtown Clayton have been published during the past three years: *Environmental Impact Report for the Oakhurst Project*, City of Clayton, February 1987, and *Environmental Impact Report for The Clayton Station Project*, City of Clayton, May 1988. The traffic count data and forecasts of cumulative background conditions in these two reports were used in this plan. Traffic generated by this Town Center Specific Plan was calculated especially for this present study. To obtain forecasts of future conditions with and without this planned Town Center, background forecasts contained in the Oakhurst EIR were used, after subtracting the traffic attributed to the Clayton Downtown Center in that previous study.

**Figure 5-1: Intersection Level of Service Definitions**

Level of Service	Interpretation	V/C Ratio
A-B	Uncongested operations; all approaches clear in a single signal cycle.	Less Than .700
C	Light congestion; occasional backups on critical approaches.	.700 - .799
D	Significant congestion on critical approaches but intersection functional. Cars required to wait through more than one cycle during short peaks. No long-standing queues (lines) formed.	.800 - .899
E	Severe congestion with some long-standing queues on critical approaches. Blockage of intersection may occur if traffic signal does not provide for protected turning movements. Traffic queue may block nearby intersection(s) upstream of critical approach(es).	.900 - .999
F	Total breakdown, stop-and-go operation.	1.00 and Above

**Figure 5-2: Existing Traffic Levels of Service**

LOCATION	ADT	V/C	LOS
<b>Streets</b>			
1. Kirker Pass at Clayton <sup>3</sup>	23,300		
2. Clayton at Washington <sup>4</sup>	17,600		
3. Main Street west of Marsh Creek Road	10,000		
<b>Intersections</b>			
1. Kirker Pass & Clayton		.73	C
2. Clayton & Washington		.55	A
3. Oak & Main		.5	

<sup>3</sup> Average Daily Traffic (ADT) shown is for Ygnacio Valley Boulevard/Kirker Pass Road.

<sup>4</sup> ADT shown is for Clayton Road.

<sup>5</sup> Unsignalized intersection. Main Street is currently operating at an acceptable Levels of Service, but not Oak Street. Oak Street intersection operations will improve after construction of the Clayton Road off-ramp.

The existing peak hour intersection conditions reported in previous studies indicate that although traffic volumes on Clayton Road/Main Street are high, the signalized intersections operate at acceptable Levels of Service. Due to high through volumes on Clayton Road/Main Street, however, side street traffic at unsignalized intersections is subject to a relatively long delay during the peak hour.

### **Programmed Improvements**

As part of the Oakhurst project, by the spring of 1991 Clayton Road will be realigned to bypass the Town Center area, and a new Oakhurst Drive will be built through the Oakhurst development to Concord Boulevard at Kirker Pass Road. Access to Town Center properties from Clayton Road would not be permitted except for the service station envisioned at the southeast corner of Oakhurst Drive and Clayton Road. This Clayton Road bypass is intended to provide relief from through traffic currently traversing Main Street which is not destined to or from Clayton residences south and east of the Town Center, or to Town Center business. These improvements will relieve Main Street of its daily load of non-stop traffic, thereby enhancing the potential of the Town Center as a retail destination.

Another major circulation change is the new Oakhurst Drive, under construction as of 1989-90. This four-lane collector street will provide access through the Oakhurst project to Concord Boulevard and Kirker Pass Road by the end of 1989. By the middle of 1990, the bypass will be completed to Center Street. During 1990, traffic will continue to use both Marsh Creek Road south of Main Street and Center Street to the Phase I end of the Clayton Road Bypass. Turns from Clayton Road both in and out of Center will be allowed during Phase I. During the latter half of 1990, construction of the Phase II Clayton Road bypass to the south will close off Center Street from the bypass until the spring of 1991, when the "split-level" Clayton Road section will be completed to Marsh Creek Road south of Bigelow Street.<sup>6</sup> Center Street will be constructed to meet Clayton Road at the terminus of Oakhurst Drive, so forming a four-way intersection controlled by a traffic signal.

(Amended by Resolution 65-96, dated 12/1/98)

After the bypass is completed in 1991, Clayton residents south of the Town Center and through traffic from Marsh Creek Road will have a choice of reaching Ygnacio Boulevard/Kirker Pass Road from Clayton Road or Concord Boulevard. Residents will also be able to bypass the Town Center via Marsh Creek Road. Clayton residents living to the east of the Clayton Road-Marsh Creek Road intersection will likely bypass the Town Center during commute hours. Those entering Marsh Creek Road between Montaire Parkway and El Molino will have a choice whether to take the bypass or go through the Town Center.

---

<sup>6</sup> Source: Richard Angrisani, Clayton City Engineer, October, 1989.

The Oakhurst project will also add 1,485 households and an 18-hole golf course to the City of Clayton. This new development will construct local streets to the north and east of the Town Center and add new traffic to Town Center roads and streets.<sup>7</sup>

### **Parking**

The existing parking supply in the Town Center area is adequate for the demand. It consists primarily of on-street parking, with the exception of parking lots provided at the Post Office parking lot, the Pioneer Inn, Village Market, and Saddlery, and a few smaller private off-street parking lots.

Although the current lack of sidewalks tends to enhance perceived parking shortages, during peak shopping periods, parking space is always available within a short distance.

### **Transit, Bicycle, and Pedestrian Circulation**

Bus service to Clayton is currently provided via County Connection route 110. Passenger buses of 44-seat capacity are operated on this route from the Concord BART station via Clayton Road, Main Street and then south on Marsh Creek Road to residential areas. Ridership is below available capacity on this route. Morning peak-period buses depart from Clayton Town Center on the following schedule, which meets BART trains at Concord.

#### **Figure 5-3: County Connection Departures from Clayton Town Center**

5:43 AM  
6:18 AM  
6:48 AM  
7:24 AM  
8:00 AM

### **Bicycle/Pedestrian Facilities**

Bicycle and pedestrian circulation in the Town Center is not specifically served by public facilities for these modes. Sidewalks are not generally available in the Town Center area, except for segments on Main and Oak Streets. Striped bike lanes are not provided on existing streets or highways. Pedestrian paths connect to Mt. Diablo Elementary School, and there is a pedestrian trail along Oak Street from the south. Bike lanes are striped on Clayton Road to the west.

---

<sup>7</sup> For details regarding the Oakhurst Project traffic impacts, see *Environmental Impact Report for the Oakhurst Project*, City of Clayton, February, 1987. The forecast traffic from this report was incorporated into estimates of background future traffic used in this plan.

## ISSUES

### Connection between Marsh Creek Road and Clayton Road

Perhaps the most important circulation issue that needed to be resolved in the Clayton Town Center Specific Plan was how to connect the Town Center to the new Clayton Road Bypass.<sup>8</sup> An easterly connection via Oakhurst, allowing access to the new Oakhurst Project, was assumed—since without it, the Oakhurst Project residents could not drive directly into the Town Center.<sup>9</sup> Marsh Creek Road needed to be connected in some way to Clayton Road through the westerly or central portion of the Town Center, otherwise, the western portion of the Town Center would be isolated from Clayton Road. The issue concerned where and how to connect between Oakhurst and the new alignment of Clayton Road as it drops down to Main Street in the western part of the Town Center. The more direct the connection between Marsh Creek Road and the Clayton Road bypass, the less relief would be provided by the new bypass from through traffic going southeast on Marsh Creek Road. Connection via extensions of Morris, Diablo, and Oak Streets, and Marsh Creek Road were all reviewed by the Specific Plan Committee. A brief summary of the connection alternatives and the design review process follows.

*The Morris Street extension* was reviewed and eliminated as inferior to the Marsh Creek Road alignment, since it would require two more turns for traffic between Clayton and Marsh Creek Roads. In addition, the Morris right-of-way contains a large Black Oak which would have required either removal or a median island to protect the tree. A median would have required acquisition of additional right-of-way.

*Diablo Street extension* was considered as an alternative to Marsh Creek Road. Advantages included a reduced grade on the westbound Clayton approach to the possible new intersection, and a traffic signal on Clayton Road which would eliminate the need for a pedestrian tunnel under Clayton Road, which would be needed with a westbound one way off-ramp to Main at Oak (discussed further below). The Diablo signal would also improve accessibility for the western part of the Town Center since it would allow all turning movements, not just right turns eastbound from Clayton Road. Diablo Street also had urban design advantages: it provided a much less direct connection between Marsh Creek Road and Clayton Road. The additional two turns and a stop that it would require of trips through the Town Center would discourage such trips more than would the Marsh Creek Road connection. Such indirectness would result in lower “background” traffic volumes on Town Center streets, especially Main Street.

Reduction of through traffic provides important safety, noise, and air quality benefits, but this advantage is offset by the loss of the “background traffic effect”—a perception

<sup>8</sup> Under construction, March, 1989.

<sup>9</sup> Funding for some of the public infrastructure of this Town Center Specific Plan is provided through an assessment district including the Oakhurst Project parcels.

that background through traffic attracts customers to commercial areas, perhaps by generating the impression that the commercial area is a lively and competitive place.

*Oak Street connection.* Several alignment possibilities were considered by the Committee. The first was to use the existing Clayton Road as a one-way eastbound off-ramp to Main. This would encourage returning commute traffic during the PM peak to continue using Main Street to Marsh Creek Road, as this route would be more direct than using a signal to make a right turn at Marsh Creek Road, Morris, or Diablo. The second was to make this ramp a two-way street, with right turns in and out at Clayton Road. This was eliminated as unnecessary, since few drivers would make a right turn onto Clayton at this location. Finally, a linear (due north) extension of Oak to Clayton with a new signal was also eliminated, due to the steep grade of Clayton Road at this location. Based on the review process summarized above, the Committee then considered two design alternatives for the connection to the Clayton Road bypass.

*Alternative 1* proposed a Diablo Street extension and signal at Clayton Road, with closure of the existing Clayton Road connection to Main Street at Oak Street. On the east, this alternative proposed the Oakhurst extension with a signal at Clayton, leaving a relatively large area uncrossed by any street between the two signals at Diablo and Oakhurst.

The major advantages of Alternative 1 were to reduce the amount of through traffic in the Town Center by preventing a direct connection to Marsh Creek Road, plus eliminating the Clayton Road pedestrian tunnel at west end of Main Street. The major disadvantages were the need to relocate the Pioneer Inn parking lot for the Diablo extension, plus the potential reduction in retail sales due to lower background traffic on Town Center streets.

*Alternative 2*, which was similar to the layout approved for funding by the Oakhurst Assessment District, proposed a one-way eastbound off-ramp down the existing hill to Main street plus a pedestrian tunnel under Clayton Road on the west. The intersection of Oak and Main would be channelized as shown on the Illustrative Site Plan (see Figure 4-3 following page 36) to ensure that drivers would not inadvertently attempt to drive up the off-ramp, and to provide a median island for this entrance to the Town Center. On the east, this alternative proposed that both Oakhurst Boulevard and Marsh Creek Road be extended to signalized intersections with Clayton Road.

The major advantage of this alternative was to provide a direct connection between the Clayton Road bypass and Marsh Creek Road, at the same time preventing outbound movements from using Main Street to Clayton Road west of Marsh Creek Road. This combination was judged by the Committee as the best way to keep through traffic off Main Street—at least in the westbound direction—while ensuring a direct Clayton Road to Marsh Creek Road connection for drivers using this route. Another advantage was the potential impetus to retail sales expected from higher background traffic on Town Center streets. The major disadvantages were the need to build the extension of Marsh Creek Road close to the fragile natural riparian habitat of Mt. Diablo Creek, and the potential

---

separation of existing (west) and new (east) areas of the Town Center caused by Marsh Creek Road crossing Main street exactly at the creek boundary between old and new.

After review and discussion, the Committee selected Alternative 2—the Marsh Creek Road extension—as the preferred means of connection between Marsh Creek Road and Clayton Road. Once the choice was made, City staff and consultants worked together to refine the design of the extension so as to preserve as much of the creekside in its natural state as possible, minimize the need to remove trees—especially large trees—and reduce the paved width to a minimum.

### **Oakhurst Boulevard Extension**

The southern terminus of Oakhurst Drive shall meet with the northern terminus of Center Street, forming a four-way intersection at Clayton Road. This intersection will provide a direct entry for residents of Oakhurst to the Town Center via Center Street.

(Amended by Resolution 65-98, dated 12/1/98)

### **Main Street Configuration**

Town Center circulation was not seen as independent from urban design and environmental concerns. These concerns played a vital part in the Committee's decisions regarding circulation design. A distinctive feature of the existing downtown area is its small-block grid street pattern—six small rectangular blocks that identify and define the Town Center.

(Amended by Resolution 65-98, dated 12/1/98)

Main Street will be the primary roadway within the Clayton Town Center. At 60 feet, Main Street is the widest street in the Town Center, a width sufficient for angle parking on one or both sides. Since parallel parking only is proposed on all other streets, this unique angle parking pattern will identify and define Main Street as the primary road identify way within the Town Center. Forty-five degree angle parking is acceptable for streets in destination shopping areas which have unlimited through traffic volumes, such as Main Street.<sup>10</sup>

(Amended by Resolution 65-98, dated 12/1/98)

---

<sup>10</sup> Locust Street, in the City of Walnut Creek, is a successful example of 45° angle parking in a 60 foot roadway.

## **CIRCULATION GOALS AND STANDARDS**

### **Roadway Improvements**

The following roadway improvements are under construction<sup>11</sup> or are proposed by this Town Center Specific Plan (See Figure 4-3, Illustrative Site Plan following page 36):

1. Clayton Road Bypass to Marsh Creek Road
2. Main Street off-ramp and Oak/Main intersection channelization
3. Oak Street pedestrian/bicycle tunnel under Clayton Road
4. Marsh Creek Road extension, including realignment of Marsh Creek road south of Main Street, bicycle and pedestrian paths, *etc.*
5. Oakhurst extension to Center Street
6. Main Street Bridge over Mt. Diablo Creek
7. Main Street extension to Oakhurst
8. Improvements to streets and construction of sidewalks on other streets as shown on the Plan.

### **Street/Road Design Standards**

The above roadway improvements will be constructed to City standards, with curb and gutter and five-foot minimum sidewalks (ten-foot recommended on Main Street). Bicycles will use striped five foot lanes on certain streets, and be prohibited on sidewalks in the Town Center. Recommended sections for these roadways are shown on page 85.

### **Parking Supply and Design**

The parking supply needed for the new land uses planned for the Clayton Town Center can be estimated by applying parking demand rates to the planned floor areas by type of use. These parking demand rates estimate the peak daily parking demand generated by each use, per unit of floor area or other measure. The demand estimate is then reduced by 15 percent for linked trips (trips for two or more destinations in the Town Center). Existing parking supply in the Town Center is assumed to remain, so that demand generated by existing uses will continue to be met as it is today, in both on- and off-street spaces. No existing excess capacity is available to meet future demand. Finally, new and converted curbside on-street parking to be constructed in the Town Center is subtracted to give an estimate of new demand for off-street parking spaces. This estimate is illustrated in Figure 5-5, on the following page. The estimated net demand is for 185 new off-street parking spaces. These 185 new off-street parking spaces could be built either by private developers or by the City, using a parking assessment district or other funding mechanism.

---

<sup>11</sup> Projects 1 through 4 are funded through the Oakhurst Assessment District.

**Figure 5-4: Roadway Sections**

Street	Recommended Width in Feet		
	R.O.W.	Roadway	Sidewalk
Main Street	80	60	10N, 7.5S <sup>12</sup>
Marsh Creek Road	68	38	7.5 + bikeway on east
Center Street	50	40	5.0

(Amended by Resolution 65-98, dated 12/1/98)

<sup>12</sup> A 10-foot sidewalk on the north side of Main Street from Diablo to Clayton Road will provide a "pedestrian boulevard," encouraging pedestrian use of this street. Of this width, 7.5 feet must be kept clear of obstructions such as street trees, poles, or waste receptacles. The 7.5-foot width is sufficient for pedestrian volumes on the south side, especially where large trees or the fronts of existing buildings would preclude the wider sidewalk design. Sidewalk width on Main Street should be increased at corners, in conjunction with the diagonal parking, to reduce crosswalk length to 34 feet (at Marsh Creek Road) or 24 feet (at other streets), and thus encourage pedestrian travel in the Town Center.

**Figure 5-5: Parking Demand**

	<b>Amount square feet</b>	<b>Rate /KSF<sup>13</sup></b>	<b>Parking space demand</b>
<b>Planned new land use<sup>14</sup></b>			
Grocery <sup>15</sup>	30,000	3.2	96
Drug	15,000	4.5	68
Restaurant	15,000	7.5	113
General	10,000	3.2	32
Convenience	8,500	6.5	4.2
Speciality	5,000	4.5	22.5
Financial	5,000	2.9	14.5
Services	7,500	4.0	30
<hr/>			
<b>Subtotal</b>	<b>96,000</b>		<b>380.2</b>
<b>Linked trips reduction :</b>		<b>-0.15</b>	<b>323</b>
<b>Planned New On-Street Parking<sup>16</sup></b>			
1. 2825 LF at 30' per space, parallel, new streets.			94 new spaces
2. 1240 LF of Main Street, from Diablo to Oakhurst, converted from parallel to 45° diagonal on both sides			44 spaces net gain
3. Subtract from #2 above if 45° diagonal parking on one side only			(22) on north side only
<hr/>			
<b>Net New Off-Street Parking Demand</b>			<b>185-207</b>

Note: Since the preparation of the parking demand projections, the Clayton Station commercial complex with 119,421 square feet of commercial space and major grocery store has been constructed. The Clayton Station project must be considered in projecting future land uses and parking demands within the Town Center area. The demand for commercial development within Clayton's Town Center was analyzed in a 1998 study conducted by the firm Keyser Marsten. This study provides revised projection for anticipated commercial development in the Town Center area.

(Added by Resolution 65-98, dated 12/1/98)

<sup>13</sup> Rate per 1,000 square feet. Source: Institute of Transportation Engineers, *Parking Generation*, 1985.  
<sup>14</sup> Mundie & Associates, *Final Market analysis for the Clayton Town Center Specific Plan*. December, 1988, "Recommended commercial uses for Clayton Town Center," Table 10, p. 39.  
<sup>15</sup> Grocery floor area was 20,000 square feet in Mundie & Associates report.  
<sup>16</sup> See Figure 5-6, page 87 for schematic design of diagonal parking on both sides of Main Street. Either one or both sides can be used for diagonal parking on this street.

### Parking Standards

Two types of parking standards are needed to ensure that adequate parking is provided for intended Town Center uses: *supply standards* and *design standards*. *Supply standards* ensure that sufficient, but not excessive, parking and loading spaces are made available concurrently with the demand for that space, within acceptable walking distance of uses generating the demand. *Design standards* ensure that access, internal circulation, stall dimensions, accessibility, and amenity (landscaping, lighting, etc.) are acceptable and consistent with other adopted design standards. Detailed examples of these two types of standards can be found in the zoning ordinances of other jurisdictions.<sup>17</sup> A representative selection of parking supply and design standards for downtowns are listed below. Many other design standards would be necessary for appropriate regulation of parking facilities—those listed illustrate some of these types of standards.

**Figure 5-6: Proposed Cross-Section for Main Street, 45° Diagonal Parking Both Sides**

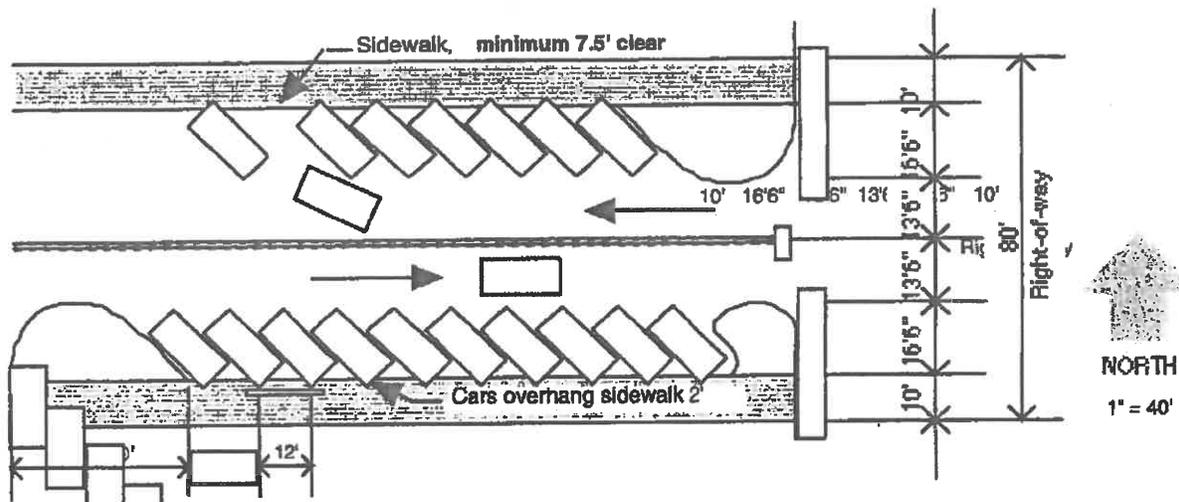

<sup>17</sup> See, for example, the City of Palo Alto *Zoning Ordinance*, Chapter 18.83: Off-street Parking and Loading Regulations. See also, the Urban Land Institute, *The Dimensions of Parking*, Washington, D.C. 152 pp., 1983.

**Figure 5-7: Parking Standards**

<b>Land Use</b>	<b>Standard</b>
<b>SUPPLY STANDARDS</b>	
<b>Parking Spaces Required per 1000 sq. ft.<sup>18</sup></b>	
<b>Non-residential land uses</b>	
Bank	2.9
Professional Office	4.0
Personal Services	4.0
Intensive Retail	4.5
Restaurant	0.25 per seat; 7.5 per 1,000 sq. ft.
<b>Residential land uses</b>	
1 space per bedroom, maximum of 2 per unit, plus 1 guest space per 10 units.	
<b>DESIGN STANDARDS</b>	
<b>Element</b>	<b>Standard<sup>19</sup></b>
Standard 90° stall	8' 6" x 18'
Angle stall	45°, 8' 6" wide
Parallel stall, closed	20' 0" long, 7' 6" wide
Parallel stall, open ended	18' 0" long, 7' 6" wide
Landscaped area	5-10% of total parking area
Aisle width	28'
Handicapped	1 per 40 spaces up to 160 spaces
Driveway width, one-way	12'
Driveway width, two-way	20'
Driveway spacing	10-15'
Sidewalk width	7' 6"; 10' 0" on north side of Main; 5' 0" on Center west of Marsh Creek.

<sup>18</sup> Adapted from: Institute of Transportation Engineers, Parking Generation, 1985.

<sup>19</sup> City of Palo Alto Zoning Ordinance, Chapter 18.83.

## **Transit Service, Bicycle, and Pedestrian Circulation**

No changes to bus frequency are needed to accommodate the Town Center Specific Plan. However, bus routes must be slightly altered to conform to the new street and road network. The Concord BART route will enter the Town Center from Clayton Road via the Main Street off-ramp, proceed east on Main Street, right on Marsh Creek Road; make a residential circuit to the south; and return via Marsh Creek Road to Clayton Road. Any new service to be provided on Oakhurst Boulevard will be routed into the Town Center via Oakhurst extension, turn right at Main Street and at Marsh Creek Road, and either right or left at Clayton Road, depending on the route back to Concord. For either route, service and stops are proposed on Main Street near the Marsh Creek Road intersection. Turn-out bus transit stops should be considered only on Clayton Road, due to its higher average speeds, but are not needed within the gridded street area of the Town Center. All bus stops in the Town Center should be provided with shelters, designed in conformance with Town Center Specific Plan design guidelines and installed with a minimum 5' 0" clear sidewalk width adjoining them.

### **Bicycles and Pedestrians**

To encourage and facilitate pedestrian travel in the Town Center, the specific plan proposes that all roads and streets—both old and new—be constructed with curbs-and-gutter and with minimum 5' 0" wide sidewalks on both sides of the streets east of Oak and north of High Streets.

### **Sidewalks**

Main street will have 10' wide sidewalks on the north side of the street and a minimum 5' clear on the south side (allow two feet for overhang of diagonally parked cars). Minimum clear width of the north sidewalk (after allowing for street furniture, landscaping, trees, and permitted encroachments) should be 7' 6"—sufficient width to allow a couple to pass a single person. Pedestrian walkways will be needed between off-street parking areas at the rear of buildings and sidewalks along the building frontage. All sidewalks must have handicap ramps at curb crossings. To provide pedestrians with the maximum clear area at crosswalks, the plan proposes design standards requiring that all sidewalks be kept clear of encroachment by trees, landscaping, lamp or sign posts, traffic signal fixtures, benches and private newspaper racks within a 5' 0" radius of crosswalk lines (7' 6" on Main Street).

All other streets and roads in the Town Center area will have 7' 6" wide sidewalks on one side of the street (the side most useful to pedestrians). For details, see Figure 5-8 on the following page.

**Figure 5-8: Planned Sidewalks**

Segment	Sidewalk Length	Width	Sq. Ft.
<b>Sidewalks on both Sides</b>			
Main Street	740'	10.0'	14,800
Center west of Easley to Oak Street <sup>20</sup>	1250'	7.5'	18,750
Diablo north of Center	220'	7.5'	3,300
Morris north of Center	220'	7.5'	3,300
Marsh Creek south of Main	410'	7.5'	6,150
	-----		-----
<b>Subtotal</b>	<b>2840'</b>		<b>46,300</b>
<b>Sidewalks on One Side</b>			
Oak north of Center, on east side	220'	7.5'	1,650
	-----		-----
<b>Subtotal</b>	<b>220'</b>		<b>1,650</b>
<b>TOTAL</b>	<b>3060'</b>		<b>47,950</b>

Note: The above estimates are based on analysis prepared for the 1990 Clayton Town Center Specific Plan. These estimates have been modified to approximate necessary sidewalk improvements following a reduction of the Town Center area in 1998.

(Added by Resolution 65-98, dated 12/1/98)

Additional pedestrian pathways or unpaved trails should be provided where needed to connect regional hiking and equestrian trails<sup>21</sup> along Mt. Diablo and Mitchell Creeks, and to the Black Diamond Mine.

<sup>20</sup> The figures are based on 7.5'-wide sidewalks on both sides of the street; however, the sidewalks on Center Street west of Marsh Creek Road may be constructed to the narrower width of 5.0 feet. See Figures 5-4 and 5-7.

<sup>21</sup> See City of Clayton, *Trail System and Open Space Master Plan* of 8/86 for a description of this regional network.

## **Bicycles**

For bicycles, five-foot striped lanes will be provided on both sides of Clayton Road, Oakhurst extension, Center Street east of Marsh Creek Road, and on Oak between Center and Main, and on the shoulder of the Clayton Road/Main Street off-ramp. Bicycle lanes are not planned for Main Street due to the potentially hazardous sightline conditions during maneuvers from diagonal parking spaces planned for this street. Signs routing bicyclists off Main to Center Street should be posted at the intersections of Main and Oak, and Main and Oakhurst. A two-way, ten-foot, bike/pedestrian, paved pathway is planned on the west side of Oak between Center Street and the north side of Clayton Road, through a new pedestrian/bicycle tunnel under Clayton Road.<sup>22</sup> Another similar ten-foot bike/pedestrian path will be constructed between Main Street and Clayton Road, along the east side of Marsh Creek Road, connecting to the crosswalk at the Clayton Road/Marsh Creek Road traffic signal. The east side of this road is preferable for this pathway, since the west side entails crossing the free-running right turn from eastbound Clayton Road to southbound Marsh Creek Road.

## **COSTS AND SCHEDULE**

### **Costs**

Preliminary cost estimates have been prepared for the circulation element of the Town Center Specific Plan, excluding those projects already included in the Oakhurst Assessment District. The estimates are preliminary planning estimates, since engineering drawings are not yet available. Standard 1989 unit prices have therefore been used to provide "ball-park" estimates for preliminary planning purposes. More precise cost estimates will be needed once engineering is completed. The estimated total planning, design and construction cost for the circulation and parking element of the Town Center Specific Plan, excluding the improvements funded by the Oakhurst Assessment District, is approximately 3.5 million dollars. For a more detailed description of this cost estimate, see Figure 5-9, on the following page.

### **Schedule**

Portions of the improvements contemplated in the Town Center Specific Plan are being designed and will be constructed by the Oakhurst Assessment District by the end of 1989. These improvements include the Clayton Road bypass to Center Street, the Main Street off-ramp and the westernmost 100 feet of Main Street, Marsh Creek Road from Center Street to the Clayton Road bypass, and the easternmost 100 feet of the existing Main Street. All the improvements west of Marsh Creek Road are to be funded in connection with the City of Clayton Redevelopment Agency. Scheduling of these improvements will be dependent upon Agency funds and property owner contributions that will be determined by the City Council.

---

<sup>22</sup> This pedestrian/bike path and tunnel project is funded through the Oakhurst Assessment District.

Clayton Town Center Specific Plan

---

Funding for the improvements east of Marsh Creek Road will have to be determined. Possible sources include the redevelopment agency, assessment bonds, and developer contributions. Once funding has been secured, design and construction of these improvements can be accomplished within 18 months. If private development is proposed in any area prior to completion of improvements, significant construction beyond the development's limits may be required if deemed necessary by the City.

**Figure 5-9: Cost Estimates**

Project <sup>23</sup>	Units	Total Cost
<b>ROADWAYS<sup>24</sup></b>		
Oak Street improvement north of Center	300 LF	8,500
Morris Street improvement	250 LF	7,100
Diablo Street improvement	250 LF	7,100
<b>Subtotal, Roadways</b>		<b>\$221,700</b>
Sidewalks <sup>25</sup>	46,300 sq. ft.	\$138,900
Parking Lots <sup>26</sup> (185-207 spaces)	64,750 to 72,450 sq. ft.	\$582,750-\$652,050
<b>TOTAL</b>		<b>\$744,350-\$813,650</b>

Note: The above estimates are based on analysis prepared for the 1990 Clayton Town Center Specific Plan. These estimates have been modified to approximate necessary improvements following a reduction of the Town Center area in 1998. Estimates for required parking have not been modified. However, given the completion of Clayton Station, a large commercial complex, and the reduction in Town Center area and size, it is reasonable to assume that needed parking in the Town Center is between 25% and 50% of the estimate provided above.

(Added by Resolution 65-98, dated 12/1/98)

---

<sup>23</sup> See text and figures for description. Excludes R.O.W. costs.  
<sup>24</sup> Excludes projects in the Oakhurst Assessment District. See Figure 5-4, page 85.  
<sup>25</sup> Details on Figures 5-4, 5-7, and 5-8.  
<sup>26</sup> Construction only. Excludes land cost for parking lots.

## Chapter 6. Financial Mechanisms For Implementing The Town Center Specific Plan

In order for downtown Clayton to develop in a manner consistent with the Specific Plan, means must be found to fund area-serving facilities such as major roads, water and drainage systems, and park and recreation facilities. These and other improvements are needed to serve future development within the planning area and, in most cases, are a prerequisite for such development. This chapter summarizes several possible methods for financing such improvements, in common use in California.

This chapter cannot be considered a conclusive description of every available financing technique, nor does it purport to have described the process for applying any particular technique with any legal exactitude. The City Attorney should be consulted for definitive guidance as to the intricacies or application of any particular mechanism.

### **MELLO-ROOS COMMUNITY FACILITIES DISTRICTS**

**Information Source: California Government Code §53311 et seq.**

**Description:** The Mello-Roos Community Facilities Act became law in 1982. It permits a legislative body to create a special district (within the legislative body's jurisdiction) that can issue tax-exempt bonds for the planning, design, acquisition, construction, and operation of public facilities as well as provision of public services to benefit district residents. Special tax assessments, levied by the district, are then used to repay the bonds. Distinctively, bonded indebtedness does not constitute an obligation of the legislative body, but rather an obligation of the district. Creation and continued operation of the district is subject to approval of (1) district land owners, or (2) if more than twelve voters reside in the district, a registered voter election. In some cases, a judicial "validation" proceeding is required (as determined by bond counsel) to verify that the special tax is not an *ad valorem* property tax.

**Uses:** A Mello-Roos district is generally created to build new public facilities in newly developing areas. A Mello-Roos district cannot be created as a technique for *replacing* existing facilities, although it may be used to *increase the capacity of* existing facilities. Bonds issued by a legislative body (issuer) on behalf of a Mello-Roos district are usually combined with other financing mechanisms such as development fees and/or exactions to cover the total cost of district public facilities development. Security for Mello-Roos bonds is in the form of a tax lien on district property. Any such property in default of property taxes (or, if separately levied, the "special tax" pertaining to the bonds) may be subject to foreclosure by the issuer.

**Example:** A developer needs capital to construct infrastructure needed to service a commercial development. It is anticipated that there will be no residents occupying the area. The City, as a legislative body, joins the developer to form a Mello-Roos district covering the area to be developed. The District then issues tax-exempt bonds which will be repaid from revenues derived through a special tax assessment on the commercial development. To retire the bonded indebtedness, the City, representing the District, each year taxes the developer the portion of the debt required to redeem mature bonds and cover the debt service on outstanding bonds for that year.

**Advantages:** The district can be designed to specifically address the needs of the property owners requesting its creation. The funds generated through the financing can be used not only to provide new public facilities and services but also to expand existing public facilities and services. Furthermore, the district can be enlarged and/or financing increased to include previously unserved or underserved areas. This method is in contrast to imposing all costs for public facilities/services in undeveloped areas—benefitting not only the development, but also property beyond the development—onto the developer; or, in more developed areas, imposing exactions or development fees onto the developer for facilities and services benefitting other property owners within the district.

**Disadvantages:** Creation and expansion of a district are both subject to action by a legislative body, but financing of district facilities by means of a special tax is subject to district landowner or registered voter approval. (If more than 12 voters reside in the district, a two-thirds majority in favor of the tax is required. If fewer than 12 voters reside in the district, then a two-thirds majority approval of property owners is required, with the votes apportioned according to the acreage owned.) If either creation/expansion or the special tax is disapproved, the developer may be discouraged from proceeding with the development which in turn may cost a city or public agency needed property tax or sales tax revenue. Also, a tax formula to repay district indebtedness must be arranged in a manner that does not become a burdensome pass-through to future property owners or tenants.

## **ASSESSMENT DISTRICTS**

### **Municipal Improvement Acts of 1911 and 1913**

**Information Source:** California Street and Highways Code §5000 *et seq.*  
and Street and Highways Code §10000 *et seq.*

**Description:** California law authorizes an assessment procedure which can be employed to pay for public improvements directly benefitting a specific area (district). Each property owner located within the district is assessed his/her proportionate share of the cost for the public improvements. Tax exempt bonds may be issued under the Improve-

ment Bond Act of 1915 or the Improvement Act of 1911 to finance the improvements. Distinct from Mello-Roos bonds, approval of an assessment district does not require a two-thirds majority vote of property owners in favor of levying a special tax because the courts have classified *special assessments* as charges for special benefits over and above public benefits received by the general public; thus, special assessments are not subject to Proposition 13 tax limitations. Notwithstanding this exception to Proposition 13, Assessment Districts are subject to the Special Assessment Investigation Limitation and Majority Protest Act of 1931 (requiring a debt limit report and public hearing, both of which may be waived under certain circumstances).

### **Benefit Assessment Act of 1982**

**Information Source:** California Government Code, §54703 *et seq.*

**Description:** This Act permits any local agency authorized to provide drainage, street lighting and/or flood control services to impose a *benefit assessment* to finance the maintenance and operation costs for such services of special benefit to properties provided with the services. The aggregate amount of the assessment is limited to the estimated annual cost of providing the service, while the assessment imposed on any parcel must be related to the benefit conferred on the assessed parcel.

Also, upon adoption of an ordinance or resolution by a local agency's legislative body imposing an assessment for the aforementioned services, a proposition must be submitted to the eligible voters within the area of benefit. The assessment is then to take effect upon majority approval of the registered area voters (or landowners if fewer than twelve registered voters reside in the assessed area). Except, under this Act, if a majority of voters in the district do not approve of the benefit assessment area, formation of it must be abandoned for at least one year. If the district is approved, then the assessment may be reviewed annually thereafter by the public agency's legislative body to determine the cost of the service, and an appropriate assessment imposed accordingly.

### **Landscaping and Lighting Act of 1972**

**Information Source:** California Street and Highways Code, §22500 *et seq.*

**Description:** This Act permits a legislative body to form an assessment district for lighting, landscaping, and related improvements and maintenance, including land acquisition and preparation for park, recreational or open-space purposes, and provision of playground facilities.

The engineer (or equivalent) of the local agency proposing the assessment must submit a report detailing plans and specifications, including a diagram of the district and

estimated costs of the improvements. If bonds are to be issued, then an estimate of their principal amount must be included.

The legislative body of the public agency must approve the report (as modified if necessary) and adopt a resolution of intent to form the assessment district. A public hearing must occur afterwards at which a majority protest may be filed contesting district boundaries and/or assessment amounts. However, distinct from a Benefit Assessment District, a majority protest by property owners representing over fifty percent of the proposed assessment district may be over-ruled by a four-fifths vote of all members of the legislative body. The assessment is then to be levied on property within the district for the fiscal year referred to in the resolution of intent upon approval of the public hearing by the legislative body, with later assessments to be levied annually according to the benefit-cost formula described under the Benefit Assessment Act above.

### **Vehicle Parking District Law of 1943**

**Information Source: California Street and Highways Code, §19000 *et seq.***

Parking facilities may be acquired and improved through the formation of assessment districts under this law. Following this approach, the costs of the parking project are assessed against individual properties in proportion to the benefits received, with each assessment representing a fixed lien against the benefitted property. The Improvement Act of 1911, the Municipal Improvement Act of 1913, and the Improvement Bond Act of 1915 have been adopted as part of the Vehicle Parking District Law of 1943. Therefore, either the 1911 Act or the 1913 Act may be used for Vehicle Parking District assessment proceedings and either the 1911 Act or 1915 Act may be used to issue bonds for the acquisition and improvement of parking facilities.

### **Street and Lighting Acts of 1919 and 1931**

**Information Source: California Street and Highway Code §18000 *et seq.***

Both Acts authorize a city to erect and maintain street lighting facilities and place an assessment for the cost and expenses of such facilities on the lands benefitted. The same resolution of intent, (describing the facilities, boundaries, cost, and assessment), hearing process, and abandonment of proceeding applies to these Acts as that described for other assessment districts; except that the city council may over-ride a majority protest by a four-fifths affirmative vote for the improvement. The difference between the two Acts appears to be that the 1919 Act provides for alternative assessment procedures; specifically, an *ad valorem* or installment assessment approach is authorized by the earlier law whereas only an annual assessment is permitted by the later law.

**Uses:** Assessment districts are normally created to finance projects which are clearly defined and of special and direct benefit to the district. Generally, water systems, sanitation facilities, streets, street lighting, flood control, sidewalks, and similar projects of limited scope and purpose are financed by creating assessment districts.

**Example:** A group of property owners want their street improved. They approach the City requesting that the improvements be installed. The City does not have the funds available and has a policy that in areas already developed, the property owners should pay for improvements. An assessment district is formed to improve the street, with the City paying a share since the street has some benefit to the whole city. Bonds are issued, and district property owners are assessed fair share portions for the cost of the street, to be repaid annually as a special assessment tax for twenty years.

**Advantages:** Assessment districts are a mechanism for providing public facilities in areas of a city where previously they may have been unaffordable. Since the facilities are of a limited scope and purpose, they do not impose a financial burden on the entire city; instead, the burden is assumed by the residents or owners who benefit the most. Accordingly, a formula for assessing district property owners can be derived to assure fairness to each property owner. The district can be established in such a way that benefits of the public improvement are maximized both by: (1) promoting development consistent with community goals; and (2) completing a major public works project within a single, continuous time frame. Security for each bond may be provided by a lien on an individual property within the district, with collection conducted by the issuer's treasurer (1911 Act). Under this approach, the *bondholder* must institute foreclosure proceedings him/herself in the event a delinquent payment is not made within one year. Alternatively, security for the bonds may be provided by placing assessment liens on district private property which the *issuer* must foreclose on in the event any property owner is delinquent in paying his/her annual levy (1915 Act).

**Disadvantages:** Pursuant to the 1911 Act, an assessment district places liens on individual private properties within the district in the form of an annual fee. Since the yield on 1911 Act bonds is predetermined by statute, potential bondholders must consider the non-negotiable risk of having to institute foreclosure proceedings. Except in the case of a prime contractor or his assignee owning the bonds (either of which may be sold the bonds at a discount), the attractiveness of 1911 Act Bonds consequently may be diminished. Regarding 1915 Act bonds, there is significant risk in their use to benefit undeveloped, solely or severally owned land because property values are relatively uncertain. If values decline too much, tax foreclosure on any one property might result in insufficient revenue to pay for the improvements. Also, formation of a district requires a great deal of staff time dedicated to designing the improvements and deriving a billing or fair share liability formula (depending on whether the overriding bond issue is based on the 1911 Act or the 1915 Act, respectively). Relatively speaking, these factors make an assessment district complex and perhaps a risky financing technique to implement and manage.

## **MAINTENANCE DISTRICTS**

### **Improvement Act of 1911**

**Information Source:** California Streets and Highways Code §5820 *et seq.*

**Description:** Under the Improvement Act of 1911, California law authorizes the formation of Maintenance Districts. The district may cover large areas of diverse location in which an annual assessment is established and paid by the property owners of the district to cover necessary public facilities maintenance, improvement, and operation expenses.

### **Open Space Maintenance Act**

**Information Source:** California Government Code §50575 *et seq.*

**Description:** This Act permits property owners to file a petition with the appropriate legislative body (*e.g.*, city council or county parks and recreation commission) to form an open space maintenance district. The district may be created to improve and maintain open spaces acquired by the legislative body (through its corresponding local agency) for open space preservation purposes. If owners of assessable land, amounting to twenty-five percent of the assessed value of all assessable land in the district, sign the petition (which must contain a description of the proposed district boundaries, the open space to be maintained, and a description of the maintenance to be conducted) a representative of the local agency must then file a report with the clerk containing the above described information and a map or diagram of the district and each parcel of land to be benefitted by the maintenance.

Resolutions of intent and public hearing are then executed by the legislative body. If at the hearing a majority of owners within the district object in writing to all aspects of the proposed maintenance, then no further action can continue regarding establishment of the district for six months. Otherwise, the legislative body may proceed with acquiring jurisdiction to form the district (if necessary), order the maintenance, and require that the cost and expense of the maintenance be paid by annual assessments upon district land on the basis of the benefit conferred on the property affected.

**Uses:** Maintenance districts normally are used to maintain improvements which are clearly defined and of limited scope and purpose. For example, these districts can provide a continuing source of revenue for the maintenance and replacement of landscaping in public rights-of-way (*i.e.*, landscaping in medians, cul-de-sacs, traffic islands, and parkway planting strips).

**Example:** A group of property owners want the public parking strip in their development maintained. The City does not have sufficient funds to provide the service but is willing to develop a unit cost for it. After adoption of a resolution of intent to form the district and public hearing as described above (taking into account that under the Improvement Act of 1911 a majority protest may be overridden by four-fifths of the city council), an ordinance is adopted forming the district and levying the assessment. Property owners are subsequently billed for the parking strip maintenance service based on a formula for the benefit each receives from it relative to the amount of property he/she owns.

**Advantages:** Maintenance districts provide a mechanism for maintaining areas that the City cannot afford to maintain. By having property owners pay for maintenance services of direct and limited benefit, City funds are freed for other uses.

**Disadvantages:** A legislative body is authorized to impose a special tax pursuant to creation of a maintenance district under the Improvement Act of 1911. The special tax, therefore, could be subject to a two-thirds majority voter approval, especially if nonpayment is grounds for foreclosure on one's property. Moreover, the maintenance fee may be subject to challenge as to whether or not property owners or resident voters will benefit at all from the maintenance or benefit in proportion to their share of the total assessment. Consequently, the process for establishing a maintenance district requires that there be a group consensus on the assessment that may be difficult to establish.

### **COMMUNITY REHABILITATION DISTRICTS**

**Information Source: California Government Code §53370 et seq. and Virginia L. Horler, Guide to Public Debt Financing in California, Packard Press, San Francisco, 1987.**

The purpose of the district is to rehabilitate public capital facilities including but not limited to, streets and roads, sewer and water pipes, storm drains, treatment plants, sidewalks, curbs and gutters, bridges, overpasses, viaducts, street lights, public buildings, flood control works, criminal justice facilities (including jails and juvenile detention facilities), libraries, parks, and recreational facilities. The district may finance its rehabilitation projects under the 1911, 1913, and 1915 Improvement Acts and the Mello-Roos Community Facilities Act of 1982 and is authorized to levy fees, charges, special taxes or other assessments on those residing within the district. In addition, up to twenty-five percent of existing property tax revenues collected from within the district may be pledged to an issue of senior obligation bonds (functionally equivalent to tax allocation bonds described under Redevelopment Districts, below) to fund rehabilitation projects.

To establish a community rehabilitation district, the legislative body must adopt a resolution of intent, which contains information concerning the types of facilities to be rehabilitated, the cost of the work, the type of bonds to be sold to finance the projects, and proposed sources of funds to pay for the work and the financing costs. After a notice and public hearing, the members of the legislative body may establish the district and appoint themselves as directors of the district. If the legislative body intends to levy taxes or assessments and proceed with an issue of bonds, the actions necessary for the type of bonds to be sold can be enacted by the legislative body while the district is being formed.

### **REDEVELOPMENT DISTRICTS**

**Information Source: California Health and Safety Code §33000 et seq. and the Directory of Housing Handbook, HCD.**

**Description:** Redevelopment Districts are used to redevelop areas defined as blighted according to the Community Redevelopment Law. In most cases, the value of property within the district is frozen for ten to twenty years, with any increase in assessed value generated through redevelopment efforts and collectable as property taxes (subject to Proposition 13 property tax limits) belonging to the district (*i.e., a tax increment*). Property taxes generated by the increase in value are used by the district to repay tax allocation bonds (pledged against tax increment revenues) or limited tax bonds (pledged against a special sales and use tax which may not exceed one percent). Such bonds are issued to finance various redevelopment district improvements as outlined in the redevelopment plan. *Note that twenty percent of the total tax increment revenues collected must be set aside for low and moderate income housing development.*

The process for creating a redevelopment district includes an evaluation of the community to identify areas of blight, preparation and adoption of a redevelopment plan, and negotiation of an agreement with other public agencies (such as school districts) enabling them to share the tax increment revenue during the life of the redevelopment district. (Such an agreement is negotiated on the basis of the burden any redevelopment project imposes on existing facilities and services financed by property taxes.)

**Uses:** Many communities have formed redevelopment agencies to improve blighted, distressed neighborhoods. Ordinarily, a district is formed to finance and promote revitalization of a dilapidated commercial and/or residential area. As part of revitalization goals, a host of improvement projects such as water, sewer, sidewalks, streets, and storm drains can be financed by establishing a redevelopment district. Also, the scope of the redevelopment plan may be broadened by an amendment to the plan, and areas contiguous to a redevelopment district may be annexed to the district. In summary, redevelopment districts promote the efficient use of land and maximization of property values and tax revenues, while simultaneously addressing the need for low and moderate income housing.

**Example:** A developer proposes a major commercial development on undeveloped land. The site is part of a redevelopment district that includes existing residentially and commercially developed land. The plan proposed by the developer suggests that the increase in property values stimulated by the development will generate sufficient property tax revenue to pay for public improvements long recognized by the City as necessary in the district. The redevelopment agency issues tax allocation bonds to finance the improvements. Ten years later, sufficient funds have been generated from district tax increment revenue to retire the bonded indebtedness and to pay for a Main Street redevelopment project located in the district.

**Advantages:** Public improvements are financed by bond proceeds, with the bonds paid from tax increment revenue in a redevelopment district. The benefit of this approach is that specific property taxes are applied to solve specific needs within the district. A district does not have to be approved by voters, and the city council may act as the board of directors for the redevelopment agency. Furthermore, based on a recent California Supreme Court decision, redevelopment authorities may make promises to developers to supply certain aspects of a development, including public facilities, with those promises constituting debt for purposes of cost recovery under the tax increment process.

**Disadvantages:** A redevelopment district trades short-run district tax revenue (used instead to service debt) in exchange for long-run returns realized from property appreciation in the redevelopment area. Redevelopment policy encourages such a trade-off for the purpose of long-term structural upgrading, including public improvements, development, and job creation in the redevelopment area. However, other public agencies that heavily rely on property taxes may sue a redevelopment agency unless an agreement is executed enabling the agencies to share the tax increment. Otherwise, the tax increment might not be used to support the affected agencies while the redevelopment continues to impose an additional burden on the agencies' facilities and services. Also, the redevelopment plan process generally requires a specialized consulting team consisting of a planner, attorney, and engineer. As a consequence, adoption of a redevelopment plan typically has a high initial cost which is commonly borne by the city's redevelopment agency.

### **GENERAL OBLIGATION BONDS**

**Information Source:** Virginia L. Horler, *Guide to Public Debt Financing in California*, Packard Press, San Francisco, 1987.

**Description:** General Obligation (G.O.) Bonds may be issued by cities, counties and school districts and are used to finance the acquisition and improvement of real property and construction of public projects of all types—so long as the cost does not include operations, maintenance, or equipment expenses. Security for the bonds derives from the

full faith and credit of the issuer (which translates as the taxing power of the city, county, or school district). The process includes identifying the project, estimating the cost, and obtaining the approval of two-thirds of the voters to issue bonds for specific, identified projects. G.O. bonds are not used very often in California due to the two-thirds "super" majority requirement (authorizing *ad valorem* property taxes at whatever rate necessary to pay off the bonds). However, where there is community consensus, G.O. bonds are very effective and inexpensive.

**Uses:** Virtually any type of public improvement project that has a community-wide impact can be financed through the use of G. O. bonds.

**Advantages:** Approval requires community consensus, which means that the community really supports the issue. The cost of issuance is very low, since the issuer places its full faith and credit behind the issue. Sometimes several projects can be linked together under a "city plan" and offered as one ballot measure, thereby broadening the scope of the voter's decision whether or not to authorize issuance of G. O. bonds.

**Disadvantages:** The need for a two-thirds majority makes approval very difficult. Failure at a bond issue election could affect any future possibilities for constructing the project if funds are subsequently found because, some will say, the citizens turned down the project at one election.

### ***PARKING LAW OF 1949***

**Information Source:** California Street and Highways Code §32500 *et seq.*

This Act empowers a city to establish a parking authority for purposes of acquiring or disposing of property for parking purposes, as well as erecting, managing, and maintaining parking facilities. The parking authority also has the power to issue revenue bonds subject to the approval of a majority of voters in the city where the facilities are to be located.

### ***PARKING AND BUSINESS IMPROVEMENT AREAS***

**Information Source:** California Street and Highways Code §36500 *et seq.*

**Description:** A Parking and Business Improvement Area encompasses commercial businesses that pay a fee, assessment, or similar charge for parking facilities, aesthetic enhancements, or general business promotion. An area is formed upon request to the city council by twenty percent of the owners of businesses within the area to be formed or by the city council which may adopt a resolution of intent to form a parking and business improvement area on its own initiative. The parking and business improvement area may

not be established if a majority of business owners within the proposed area file written protests which are ruled upon at a public hearing addressing the city council's resolution of intent to establish the area. Otherwise, the city council may adopt an ordinance establishing the area and levy an assessment according to the estimated benefit to the businesses within the area. Funds collected in a parking and business improvement area must be used to benefit the area in which the assessments are collected, and each business may be assessed based on its type, size, and location as well as the cost of the service or improvement provided.

**Uses:** Possible uses of a parking and business improvement area include:

- Improving appearance, cleanliness, safety, and customer convenience.
- Conducting local promotions for purposes of maintaining and improving the mix of retail, office, and service businesses.
- Funding of marketing campaigns.
- Providing a source of matching funds as an incentive for streetscape and parking improvement projects to be undertaken by the City.

**Example:** A consortium of downtown businesses forms and wants to offer joint advertising. No individual wants to assume the responsibility for collecting fees. The City offers to collect the fees as part of a business improvement area. The area is formed, and through the participation of the businesses in a goal-setting session, numerous other ideas are generated. The City staff estimates the cost of the projects and programs identified and returns to the group with some ideas for assessments. After discussion, the group agrees to assess themselves \$100 to \$350 per business annually.

**Advantages:** This financing mechanism gets businesses located in the same proximity involved in supporting projects and programs that will benefit those same businesses. A parking and business improvement area also provides a constant source of income for the area so that projects and programs can be undertaken and goals for the area achieved over time. Moreover, support from the community-at-large for business improvement area projects has no financial burden associated with it.

**Disadvantages:** Although the City may recognize needed improvements that will directly and substantially benefit businesses located in the same proximity, there is no guarantee that those businesses will agree on the formation of a parking and business improvement area, or, if formed, agree with the City-recognized needs, or agree with the City on the share the business improvement area should contribute for any improvement. Also, there is no guarantee that the area will continue on a long term basis. Furthermore, a disagreement or a change of ownership among any participating businesses could disrupt the continuity of progress which the program facilitates.

## **PARKING DISTRICT LAW**

**Information Source: Street and Highways Code §35100 et seq.**

Similar to a parking and business improvement area, a parking district may be established by property owners representing fifty-one percent of the total assessed value of real property in the proposed district. Upon submittal of a petition describing the boundaries of the district, the parking places to be acquired, public ways for ingress to and egress from the parking places, improvements to be made, and cost and revenue information, the city council may adopt a resolution of intent to form the district.

The resolution must be heard at a noticed public hearing and, if no majority protest is filed or recognized, adopted as an ordinance, with modification if necessary. In accordance with the ordinance, an assessment is then levied on district property—in much the same manner as a parking and business improvement area—to pay for the parking facilities (or bonds authorized to be issued for the same purpose).

## **CERTIFICATES OF PARTICIPATION**

**Information Source: Virginia L. Horler, Guide to Public Debt Financing  
In California, Packard Press, San Francisco, 1987.**

**Description:** Certificates of Participation (COPs) governed by California case law can be used to finance municipal improvements and qualifying private projects that have a specific cash flow (such as a long-term lease), or a special fund, established in both cases to secure COPs. A primary issuer of certificates is the California Cities Finance Corporation (CCFC). The CCFC pools COP-financed projects from cities throughout California and issues certificates periodically to finance groups of public improvements. Collateral for the certificates are the leases and installment sales contracts which are enhanced by various insurance policies. In order for *lease-backed* COPs to be tax-exempt, the lease must be considered a *sale* agreement entered into under the public entity lessee's borrowing power. The I.R.S. also requires that the lease term be limited to no more than the anticipated useful life of the lease property. Additionally, lease-backed COPs are exempt from Proposition 13 debt limitations; therefore, no voter approval is required for this type of COP issuance.

COPs supported by an *installment sales agreement*, on the other hand, are subject to the Proposition 13 debt limitation unless the public entity issuer creates a special obliger fund, distinct from the public entity's general revenue fund, and appropriates COP payments from that fund. COPs backed by an installment sales agreement are exempt from federal income tax because a public entity is financing a public purpose facility.

**Uses:** Cities have used certificates for every type of major municipal purchase, including, for example, the purchase of a private water system.

**Advantages:** Certificates avoid the difficulty of a two-thirds majority vote. Also, the interest rates are very reasonable (compared to bank loan rates) when the certificates are tax exempt. Altogether, the procedure is very rapid, with financing usually requiring less than 120 days.

**Disadvantages:** A certificate issue needs to be tied to a specific source of revenue for repayment. In the case of the water system purchase, water service fees are pledged to repay the debt. Bond financing options pledge city tax or assessment revenues which are more secure: thus, they have lower interest rates. Moreover, as a consequence of the annual appropriation for an installment sales agreement type of COP issue, the city's balance sheet can be adversely affected.

### ***DEVELOPMENT FEES***

**Information Source:** California Government Code §66000 *et seq.*

**Description:** Development fees are implemented by a public agency upon review of a study of the actual costs for public facilities or services needed to serve a specific development. It is advisable in light of recent court rulings that local agencies adopt programs (*e.g.*, a Capital Improvement Program) which establishes a "reasonable relationship" between imposition of the fee and the type of development project for which the fee will be used.

**Uses:** The fees can be immediately spent on site-related public improvements or saved for less than five years after which the public agency must make a finding as to the reasonable relationship between the fee and any proposed use of it. Possible development fees include:

- Water Modelling and Connection Fees (to contribute to the payment for and operation and maintenance of new and existing water facilities);
- Community Facilities Development Fees (for construction of major public improvements, the cost of which is borne by the developments that generate the need for the improvements);
- Storm Drainage Impact Fees (for the purpose of improving, operating, and maintaining increasingly burdened sewerage facilities, calculated on the basis of the estimated increase in water runoff attributable to a proposed development);

- Park and Recreation Land Improvements (for acquisition, development, and improvement of neighborhood and community park and recreation facilities);
- In-Lieu Housing Fees (as an option for developers to meet the housing policies of a city's General Plan requiring contributions to the housing stock relative to the size of a commercial or industrial development);
- Traffic Modelling and Mitigation Fees (for construction of major roadway and traffic improvements attributable to a proposed development. The traffic impact data are derived from established trip-generation rates for various land uses);
- Building Permit and Planning Processing Fees (to pay for building inspection and planning services including a share of the cost for the City's need to regularly update its General Plan); and
- School District Fees (for providing permanent school sites or financing interim school facilities necessitated by new residential development).

**Advantages:** The fees are paid by the developer and passed on to the purchaser or lessee of the property. There are no requirements for voter approval, and the City receives fees for any public improvement prior to construction on the development site. This approach protects residents of the community from having to finance or pay for public facilities which become necessary to accommodate large scale private development.

**Disadvantages:** Fees can increase the cost of development beyond the average home-buyer's or tenant's ability to pay. Consideration should be given to alternatives such as in-lieu mechanisms for large commercial developments (e.g., land dedications or reservations). Also, derivation of a fee formula may require a large block of staff time and effort to assure fairness.

### **REVOLVING LOAN FUNDS AND TRUSTS**

**Information Source: California Government Code §55314.5 and Directory of Housing Programs, HCD.**

**Description:** California Law authorizes revolving loan funds from moneys available to legislative bodies that have adopted Mello-Roos Community Facilities Districts and from the Predevelopment Loan Program.

The legislative body adopting a community facilities district may issue loans from legislative body funds for purposes of property acquisition, engineering services, or the

construction of district facilities. The borrowed funds are then to be repaid with interest within five years from the date when tax revenues or other moneys become available from the district.

The Predevelopment Loan Program, administered by the California Housing and Community Development Department, provides "seed money" for local agencies and non-profit corporations targeting the development or rehabilitation of low income housing in both rural and urban areas. Among other things, a Predevelopment loan may be used for site preparation expenses, such as water and sewer facilities installation. Although individual loans are limited to a term of one to three years, the 7% interest rate may be reduced or eliminated if the loan committee finds that it would prohibit significant numbers of very low income persons from owning or occupying units within the funded project.

**Uses:** A Parks Trust, whose funds are restricted to use for park purposes, could loan funds to the parks department for repayment over time, thereby maintaining the integrity of the trust while providing an excellent source of funds for park-related improvements and maintenance.

**Advantages:** Provides an on-going source of revenue, albeit of limited supply, for building rehabilitation and other public purpose projects.

**Disadvantages:** Usually such funds are not available in the large sums necessary to finance most public facilities projects.

### **FEDERAL ECONOMIC DEVELOPMENT ADMINISTRATION (EDA)**

**Information Source:** Directory of Housing Programs, HCD.

The EDA sponsors various funding programs for research, technical assistance, and development initiated by local agencies and non-profit corporations. Step one of the qualification process for EDA assistance is the establishment of an *Overall Economic Development Program (OEDP)* Committee representing the community at-large. After an analysis of the area's economic activities, resources, and potential, as well as documenting a strategy for maximizing local economic and social capabilities, the OEDP adopted by the Committee is submitted to the EDA for approval. Upon approval of the OEDP, all public works and business development projects proposed for EDA assistance must be consistent with the OEDP.

*EDA redevelopment areas* that are delineated in the OEDP on the basis of specific statistical requirements are eligible for the complete range of EDA benefits. Economic Development Districts, on the other hand, target a multi-jurisdictional area since an

individual redevelopment area often lacks sufficient resources for a solid economic base. By grouping together distressed areas with those of economic health, the Economic Development District fosters development on a large scale. Among the grants available from EDA are: Administrative Expense Planning Grant, Comprehensive Economic Development Grant, Assistance to Districts for Professional Services, and Research Assistance. A fifth grant, the Public Works Program, provides funding for commercial and industrial site-related public utilities, construction of job-training facilities, public facilities at airports, harbors, blighted or congested commercial areas, publicly owned recreational facilities to enhance the area's tourism industry, and the renovation of inner-city buildings for special development purposes. EDA funds 50% of eligible projects and in some cases 80%–100%. Ineligible projects include those that are highly speculative or lack job creation and business development potential, or those that do not provide benefits to the poor and unemployed.

### **STATE OF CALIFORNIA COMMUNITY DEVELOPMENT BLOCK GRANTS (CDBG)**

**Information Source: Directory of Housing Programs, HCD.**

As a city with a population under 50,000, Clayton may compete for funds from the Community Development Block Grant non-entitlement Program. Three eligible activity areas qualify: housing, public facilities, and economic development. Furthermore, at least one of three program objectives must be addressed—benefit to lower income people, elimination of slums or blight, or resolution of urgent community development needs. Eighty-one percent of the State's non-entitlement funds are earmarked for lower income housing development and economic development assistance. The economic development assistance includes funding for the off-site improvements necessary for businesses to locate in qualifying cities, granted under the proviso that the businesses provide permanent employment opportunities for lower income residents.

The four evaluation criteria for a non-entitlement grant are:

1. The relative extent of poverty within the community.
2. The relative benefit of each applicant's program to lower income households.
3. The relative seriousness of the needs each applicant proposes to remedy, the effectiveness of proposed resolutions, and the consistency of these proposals with State objectives; and
4. The relative cost-effectiveness of each applicant's program.

Programs that have been funded in the past include water, sewer, and infrastructure repair projects.

## **CREEKS, OPEN SPACE, AND TRAILS**

### **Information Source: Urban Stream Restoration Program, California Department of Water Resources.**

The objectives of this program are to assist communities in reducing damages from stream bank and watershed instability and floods, while restoring the environmental and aesthetic values of streams, and to encourage stewardship and maintenance of streams by the community. The program provides technical assistance to communities in designing solutions to flooding and bank stability problems and developing land use regulations to manage floodways and riparian environments. The program also provides grants on an annual cycle for on-site stream restoration work, design of restoration and flood damage reduction plans, organization of volunteer maintenance and monitoring projects, and acquisition of greenbelts along streams.

Counties, cities, and non-profit organizations are eligible to receive grants from the Urban Stream Restoration Program. The program's enabling legislation requires that the proposed projects restore or enhance the aesthetic, recreational, fish and wildlife values of the waterways. Proposals which stress community involvement are given a high priority. Small neighborhood, community organizations, or service groups are encouraged to apply by making arrangements with non-profit organizations or local governments to be their sponsor. Typically, the Department of Water Resources mails out requests for grant proposals in the fall. Proposals are reviewed in December or January, and arrangements for the transfer of grant monies to the successful applicants are made in the winter and spring. Project completion is usually expected within a year from the time the grant is awarded. To qualify, an applicant needs to have two objectives: first, restoring environmental resources and, second, addressing a problem of watershed stabilization or flooding.

### **Information Source: California Department of Fish and Game, Inland Fisheries Division Grant Program.**

The Department of Fish and Game (DFG) provides grants for fishery restoration work. Typically, the application deadline falls in April, and funds are not available to successful applicants until at least September. Proposals are reviewed by the appropriate DFG unit biologist and for some sources of funding by the Salmon Stamp Committee or the Advisory Committee on Salmon and Steelhead Trout. Funds for this program come from a variety of sources:

- **The California Wildlife, Coastal, and Park Land Conservation Bond Act of 1988 (Proposition 70).** This Bond Act authorized various programs for purposes of park and recreation land and facility acquisition, development, and rehabilitation. These

programs, described in Figure 6-1 on the following page, also include funding for innovative programs, major maintenance projects, and archeological resource preservation. The DFG provides funds for the restoration and enhancement of salmon, native steelhead trout, and wild trout habitat.

- **The Cigarette and Tobacco Tax Benefit Fund (Proposition 99)** provides funds to benefit fish and wildlife. For both Prop 70 and Prop 99, funds may be available from the Wildlife Conservation Board (WCB) as well as the DFG. Approximately \$3 million was available from these sources in fiscal year 1989-90.

- **The Salmon Stamp program** provides funds for projects directed at restoring salmon populations through habitat enhancement or fish rearing, and to projects designed to educate the public on the importance and the ecological and environmental requirements of salmon. Anyone may apply. Action projects are preferred to studies, evaluations, or monitoring. Approximately \$500,000 was available in fiscal year 89/90.

- **The 1984 Fish and Wildlife Enhancement Bond Act (Proposition 19)** provides funds through the Wildlife Conservation Board to correct the more severe deficiencies in fish and wildlife habitat in California. Funds may be used only by public agencies to enhance, develop, or restore flowing waterways for the management of fish *outside the coastal zone*. Individuals or groups must affiliate with or act as the agent of a public agency to be eligible for these funds. Approximately \$1 million was available for new projects in fiscal year 1989-90.

**Information Source: State Water Resources Control Board,  
Clean Water Construction Grant Program.**

The State Water Resources Control Board provides water quality management planning grants to State, local, and regional agencies to address a wide variety of surface and groundwater quality problems. These funds are provided by the Federal government under sections 205(j) and 604(b) of the Clean Water Act. Approximately \$1.2 million will be available per year for fiscal year 1989 and fiscal year 1990.

The funding emphasis will be on projects that focus directly on corrective or preventive actions for "State identified water quality impacted water bodies," proposed by agencies with the capacity to perform and complete the proposed work. However, projects that focus on other water quality problems will also be considered. Projects which are primarily research will not normally be funded.

Figure 6-1: Summary of Grant Programs Under Proposition 70

SUMMARY OF GRANT PROGRAMS UNDER PROPOSITION 70, OCTOBER 1989  
 DEPARTMENT OF PARKS AND RECREATION  
 OFFICE OF LOCAL ASSISTANCE  
 P.O. BOX 942896, SACRAMENTO, CA 94296-0001 PHONE: (916) 445-4441

PROGRAM	TOTAL DOLLAR AMOUNT	COMPETITIVE OR BLOCK GRANT	APPLICATION DEADLINE	ELIGIBLE APPLICANTS	ELIGIBLE PROJECTS
Special District	\$10 mil. over 2 years (\$5 mil. in FY 89/90; \$5 mil. 90/91)	Competitive	September 15, 1989 for FY 90/91.	Special Districts who provide significant recreation services and are not eligible for funds under the Per Capita Program.	Acquisition, development rehabilitation of parks
Trails	\$5 mil. over 2 years (2.5 mil. in FY 89/90; \$2.5 mil. 90/91)	Competitive	Sept. 15, 1989 for FY 90/91.	Local units of governments and nonprofit organizations authorized to provide park, recreation or open space services or facilities.	Acquisition, development, rehabilitation of trails.
Per Capita	\$120 million	Block Grant	September 15, 1989 for FY 1990/91; September 15, 1990 for FY 1991/92.	Cities, counties, park & recreation districts, regional park districts, open space districts, & other qualifying districts.	Acquisition, development rehabilitation of parks & recreation.
Robert Z'Berg Harris	\$20 million (70% State; 30% Local Match)	(1) Block Grant \$16,351,000  (2) Needs Basis \$ 2,947,120 \$ 401,880	(1) Application period is July 1, 1989 thru June 30, 1990. Agreement must be fully executed by 6/30/90.  (2) October 1, 1989.	Cities, counties, qualifying special districts (as defined in Act).	Acquisition, development, rehabilitation of parks & recreation. Up to 30% may be used for innovative programs and special major maintenance projects.
Specified Local Agency	\$185.4 mil	N/A	Funds are available for ten years beginning June 8, 1989. Applications may be submitted anytime.	Only agencies specifically mentioned	Acquisition & development, specified in the Act.
History & Archeology	\$11 mil (1 mil for Archeology Projects)  \$50,000 minimum grant	Competitive	December 1, 1988.	Local units of government and nonprofit organisations. Contact Office of Historic Preservation P.O. Box 942896, Sacramento California, 94296-0001 (916) 445-8006	Acquisition, development, rehabilitation, restoration of archeological resources.

**Information Source: Trails Grant Program  
California Department of Parks and Recreation**

**Eligible applicants:** Local units of government and nonprofit organizations authorized to provide park, recreation, or open-space facilities or services to the general public.

**Eligible projects:** Acquisition of property for trails; development or rehabilitation of trail facilities.

**Eligible costs:** Acquisition and construction costs; consultant services; signs and interpretive aids; administrative and planning costs not to exceed 20% of the grant.

**Amount and timing of grants:** Applications are due 9/15/89 for the fiscal year 90/91 allocation of \$2.5 million.

**Information Source: Land and Water Conservation Fund Program,  
California Department of Parks and Recreation.**

**Eligible applicants:** Counties, cities, recreation and park districts, special districts with public park and recreation areas, the California Department of Parks and Recreation, the Wildlife Conservation Board, the California Department of Boating and Waterways, and the California Department of Water Resources.

**Eligible projects:** Acquisition or development of neighborhood, community, or regional parks or facilities supporting outdoor recreation activities.

**Amount and timing of grants:** This is a reimbursement program; the applicant is expected to finance the entire project. Fifty percent of actual expenditures up to the support ceiling of the grant, minus 1/2 of the state's cost of administering the program, will be paid to the applicant when the project is completed.

In 1989 the application deadline was March 30; \$222,058 was available for northern California and \$333,087 for southern California local agencies.

**Information Source: Per Capita Grant Program,  
California Department of Parks and Recreation.**

**Eligible applicants:** Counties, cities, and certain park, open-space, or recreation districts.

**Eligible projects:** Acquisition of open-space or lands or structures to be converted to recreational use; development or rehabilitation of park or recreation facilities; acquisition, preservation, reconstruction, or restoration of certain historic sites.

**Eligible costs:** Acquisition and construction costs; consultant services; signs and interpretive aids; and administrative and planning costs not to exceed 20% of the grant.

**Amount and timing of grants:** Minimum of \$20,000; applications are due 9/15/89 for fiscal year 90/91 and 91/92 appropriations; project must be started within three years of the date of appropriation.

**Information Source: Special Districts Grant Program,  
California Department of Parks and Recreation.**

**Eligible applicants:** Special districts which provide significant park and recreational opportunities to the general public but which are not eligible for the Per Capita Grant Program.

**Eligible projects and costs:** Same as for the Per Capita Grant Program.

**Amount and timing of grants:** Minimum of \$20,000; a total of \$5 million is allocated for fiscal year 90/91; applications are due 9/15/89 for fiscal year 90/91; project must be started within three years of the date of appropriation.

**Information Source: Robertl-Z'berg-Harris Urban Open Space and  
Restoration Grant Program,  
California Department of Parks and Recreation.**

**Eligible applicants:** Counties, cities, certain regional park districts, recreation and park districts, public utility districts and memorial districts that offer park and recreation services on district land, community services districts that provide public recreation, and certain other special districts.

**Eligible projects:** Acquisition of open-space or lands or structures to be converted to recreational use; development or rehabilitation of park or recreation facilities; acquisition, preservation, reconstruction, or restoration of certain historic sites; special major maintenance projects performed on an annual or less frequent basis; innovative recreation program specifically designed for unique and otherwise unmet recreation needs of special urban populations such as senior citizens, disabled, poor, single parents, "latchkey" children, or minorities.

**Eligible costs:** Acquisition and construction costs; consultant services; signs and interpretive aids; administrative and planning costs not to exceed 20% of the grant; special major maintenance, project, and innovative recreational program costs not to exceed 30% of the amount received in an annual period.

**Amount and timing of grants:** Deadlines for application are established annually by the Department of Parks and Recreation, usually October 1 of the fiscal year the funds are appropriated. These are matching grants with a minimum local match of 30% of the allowable project cost. Grants for development may be matched by monetary contributions or by non-monetary contributions including property donations and in-kind contributions. One-third of the match must consist of monies or contributions from private or nonstate source, unless waived; other restrictions may also apply.

**Information Source: The Foundation Center Library, San Francisco**

The Foundation Center is a national service organization providing information on philanthropic giving, and may be able to help find the best place to apply for foundation funding. The Center's library network provides free access to the materials needed to do funding research and develop a proposal.

The Foundation Center produces a number of useful publications for fund seekers and nonprofit organizations, including the *Foundation Directory*, the *National Directory of Corporate Charity*, the *Foundation Grants Index*, and *The Board Member's Book*. All of the Center's publications are available for reference use at the Foundation Center Library. □

## Appendix A. Preservation Of Mature Trees

The community recognizes that native oaks and other mature trees are important historical, aesthetic, and ecological resources that contribute to the distinctive character of Clayton. The City's Municipal Code and Ordinances provide for the preservation of trees, and regulate the removal of trees. The purpose of this Guideline is to create favorable conditions for the preservation and propagation of this irreplaceable plant heritage.

### **DEFINITIONS**

- "Mature tree" shall mean any tree which is more than 8 inches in diameter as measured 4 feet 6 inches above the root crown.
- "Mature oak tree" shall mean any tree of the *quercus* genus more than 6 inches in diameter as measured 4 feet 6 inches above the root crown.

### **GUIDELINES**

Site development plans should demonstrate a diligent effort to retain as many native oak and other mature trees as possible. In addition, other existing trees should be preserved to the maximum extent possible.

### **Criteria for Removal**

In assessing the number of trees and the specific trees that may be removed, the applicant and Planning Commission should consider the following criteria:

- The condition of the oak or other mature tree with respect to disease, danger of falling, and the proximity to existing or proposed structures. Should debate over the health of the tree arise, a licensed arborist should be consulted at the expense of the applicant.
- The necessity to remove an oak or other mature tree in order to construct proposed improvements to prevent extreme economic hardships to the owner of the property.
- The topography of the land and the effect of oak or other mature tree removal on erosion, soil retention, and the diversion or increased flow of surface waters.
- The number of oak or other mature trees existing in the neighborhood. Decisions should be guided by the contribution of mature trees to the visual character of the neighborhood.
- Accepted professional (urban) forestry practices, such as the number of healthy oak or other trees which a given parcel of land or area can support.

## Where Mature Trees Have Been Removed

Tree Removal Permits may require the replacement or placement of additional trees on the subject property to offset the impacts associated with the loss of a tree, limbs, or encroachment into the protected zone of an oak tree. The permit may require relocating a tree on-site or off-site, or the planting of a new tree to offset the loss of a tree.

Prior to issuance of a permit to remove a tree, the following steps shall be taken:

- Determine the condition of the tree, based on structure, potential disease(s) and overall health, using a certified arborist (with demonstrated experience in Oak tree management).
- The Canopy of the tree shall be determined.
- Replace the designated tree canopy. This can be achieved by selecting a specimen (boxed) tree, or alternatively, by multiple tree planting which in the aggregate will equal the canopy of the tree removed. Multiple trees may require thinning and removal at a later time in order to promote healthy growth. If site conditions preclude multiple tree replacement, the balance of the trees required to replace the canopy cover shall be planted in another location as determined by the Planning Director.

## Grading Techniques for the Preservation of Oaks

The most critical issue in the care and maintenance of an existing oak is the altering of conditions under which that tree has grown for possibly 100 or more years. "Altering" includes changing the grade within the drip line, changing watering practices from natural rainfall to supplemental irrigation, changing the leaf litter beneath the trees, changing drainage patterns, and compacting of soil around roots caused by heavy equipment.

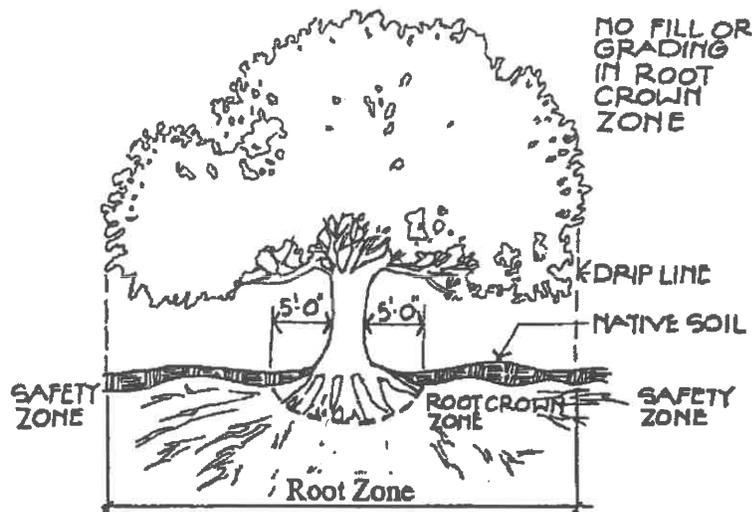

- Should changes of grade be necessary, the following steps should be taken:

1) Establish radius of the existing root system by using soil probes or other means. This establishes a Root Crown Zone within which there should be no grading. New development may require gradual root pruning. Consult a arborist for proper techniques. Root pruning enables roots to be cut for a lowering of the natural grade. Under no circumstances should soil be added around the Root Crown Zone, but soil may be added over the Root Zone if the root crown is protected by retaining devices.

2) Overwatering oaks during the summer creates conditions favorable to root rot and oak root fungus. Besides reducing water to the root zone, draining water off the root crown quickly is vital for the health of the tree. Sloping soil away from the root crown improves drainage by creating rapid water runoff. In heavy soils, such as clays, leach lines installed within the drip line and extending out to drainage courses may be necessary to increase drainage. In all cases, the goal is to duplicate the native conditions under which the oak has lived. Essentially, if the existing conditions were dry, leave them dry; if they were wet, leave them wet.

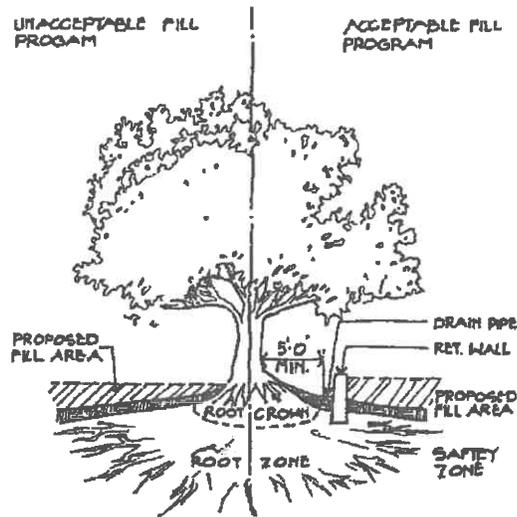

3) Leaf litter is the accumulation of live and decaying leaves at the base of a tree. In the case of oaks, this litter contributes to a cool atmosphere for root growth, and an acid condition resulting from the decaying of the leaves. When possible, leave the natural litter in place.

4) Poor drainage caused by a change in grade or compaction produces constant moisture at the base of the trunk. Growing lawns beneath oaks also frequently produces poor drainage. This problem can be averted by using other ground covers, sloping the natural grade away from tree, and diverting sprinklers away from the trunk. A dense turf or compacted soil can greatly reduce aeration in the soil. Reduced aeration plus excessive water favors development of harmful soil organisms, such as oak root fungus, which may be present in an inactive stage until stimulated by favorable growing conditions or even mechanical root injury.

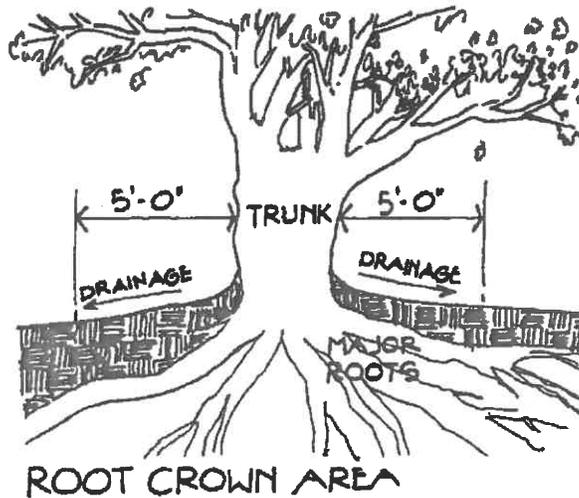

In summary, native oaks are extremely sensitive plants. Minimal grade changes within the drip line can drastically affect aeration of the roots and drainage around the root crown. Avoid changes of grade, if at all possible. Avoid summer irrigation which would produce constant moisture at the root crown. Treat oaks with the care they deserve. □

## Appendix B. Plant Selection Guide

### TREES

#### Large, above 50 feet in height

##### Coniferous Evergreen

*Calocedrus decurrens*

*Cedrus deodara*

*Pinus halepensis*<sup>1</sup>

*Pinus pinea*

*Pinus radiata* (existing)<sup>2</sup>

*Sequoia sempervirens*<sup>3</sup>

Incense Cedar

Deodar Cedar

Aleppo Pine

Italian Stone Pine

Monterey Pine

Coast Redwood

##### Broadleaf Evergreen

*Eucalyptus sp.* (existing)

may be satisfactory.

Bluegum

There are many other species which

##### Deciduous

*Alnus rhombifolia*

*Juglans nigra*

*Platanus acerifolia*

*Populus fremontii*

*Quercus lobata*

White Alder

Black Walnut

London Plane, Sycamore

Cottonwood

Valley Oak

#### Medium, 30 to 50 feet in height

##### Broad leaf Evergreen

*Ceratonia siliqua*<sup>4</sup>

*Eucalyptus sp.*<sup>5</sup>

Carob Tree

<sup>1</sup> *Pinus halepensis brutia* (Calabrian Pine)  
Denser, more erect than related *P. halepensis*. Faster, shapelier tree than related *P. halepensis*; form is less interesting at maturity. (Sunset New Western Garden Book)

<sup>2</sup> *Pinus radiata* (Monterey Pine)  
More reliable near the coast than in the warmer interior valleys of Contra Costa County.

<sup>3</sup> *Sequoia sempervirens* (Coast Redwood)  
One of best growing places is in or next to lawn. Thrives on a luxurious supply of water. Away from lawns it needs occasional feeding and regular summer watering (at least for the first five years). (Sunset)

<sup>4</sup> *Ceratonia* (Carob), *Olea* (Olive), and *Schinus* (Pepper) are all fine, vigorous, messy, spreading trees which need adequate space away from walks, streets, and garden areas

<sup>5</sup> *Eucalyptus pulchella* *E. linearis* (White Peppermint)  
Graceful tree to 25-50 ft. with weeping branches. Can be either asymmetrical or round-headed. Long, very narrow, dark green, pendulous leaves. White to light tan bark peels in thin strips. Fine landscaping and street tree.

<i>Maytenus boaria</i>	Mayten Tree
<i>Magnolia grandiflora</i>	Southern Magnolia
<i>Olea europea</i> <sup>4</sup>	Olive
<i>Quercus agrifolia</i>	California Live Oak
<i>Quercus ilex</i>	Holly Oak
<i>Quercus suber</i>	Cork Oak
<i>Schinus molle</i> <sup>4</sup>	California Pepper

**Deciduous**

<i>Acer Macrophyllum</i>	Bigleaf Maple
<i>Aesculus californica</i>	California Buckeye
<i>Ailanthus glandulosa</i>	Tree of Heaven
<i>Fraxinus oxycarpa</i> Raywood	Raywood Ash
<i>Juglans regia</i>	English Walnut
<i>Pistacia chinensis</i>	Chinese Pistache
<i>Salix babylonica</i>	Weeping Willow

**Small, 15 to 30 feet in height**

**Broadleaf Evergreen**

<i>Arbutus unedo</i>	Strawberry Tree
<i>Eucalyptus sp.</i>	
<i>Eriobotrya sp.</i>	Loquat
<i>Hymenosporum flavum</i>	Sweetshade
<i>Quercus dumosa</i>	California Scrub Oak
<i>Magnolia sp.</i>	Flowering Magnolias
<i>Schinus terebinthefolius</i>	Brazilian Pepper
<i>Trachycarpus fortunei</i>	Windmill Palm

**Deciduous**

<i>Acer palmatum</i>	Japanese Maple
<i>Cercis sp.</i>	Redbud
<i>Crataegus sp.</i>	Hawthorn
<i>Ficus carica</i>	Fig
<i>Lagerstroemia indica</i>	Crepe Myrtle
<i>Prunus sp.</i>	Flowering Plum, Cherry
<i>Malus sp.</i>	Flowering Crabapple
<i>Pyrus calleryana</i> Bradford	Bradford Pear
<i>Salix sp.</i>	Creek Willow

Beautiful form and willowy, well-mannered. Dark, dense foliage, masses contrast with light trunk. Good in light soils with little water. (Sunset)

These are upright trees of elegant character, unlike their larger and more gross cousins which are better known because of the vagaries of plant importation and distribution. They are suggested for the Oakhurst corridor because of their form and restraint. Buckeye and Toyon are too spreading and intrusive for the spaces in this corridor.

---

**SHRUBS**

**Large, above 10 feet in height**

<i>Arbutus unedo</i>	Strawberry Madrone
<i>Cercis occidentalis</i>	Western Redbud
<i>Magnolia liliflora</i>	Lily Magnolia
<i>Myrica californica</i>	Pacific Wax Myrtle
<i>Pittosporum eugenioides</i>	Tarata
<i>Prunus laurocerasus</i>	English Laurel
<i>Prunus lusitanicus</i>	Portugese Laurel
<i>Viburnum sp.</i>	No common name

**Medium, 5 to 10 feet in height**

<i>Abelia grandiflora</i>	Glossy Abelia
<i>Arctostaphylos densiflora McMinn</i>	Manzanita
<i>Aucuba japonica</i>	Gold Dust Plant
<i>Berberis thunbergi</i>	Barberry
<i>Buxus microphylla japonica</i>	Japanese Boxwood
<i>Ceanothus Frosty Blue</i>	No common name-Wild Lilac
<i>Chaenomeles japonicus</i>	Flowering Quince
<i>Cotoneaster lactea</i>	Red Clusterberry
<i>Eleagnus pungens (and variations)</i>	Silverberry, Yellowedge
<i>Escallonia exoniensis Fradesii</i>	Frades Escallonia
<i>Fatsia japonica</i>	Aralia sieboldi
<i>Forsythia suspensa</i>	No common name
<i>Grevillea Canberra</i>	No common name
<i>Ilex cornuta</i>	Chinese Holly
<i>Hydrangea macrophylla</i>	Garden Hydrangea
<i>Ligustrum texanum</i>	Texas Privet
<i>Mahonia aquifolium</i>	Oregon Grape
<i>Mahonia pinnata</i>	California Holly Grape
<i>Myrtus communis</i>	Roman Myrtle
<i>Nandina domestica</i>	Sacred Bamboo
<i>Nerium oleander</i>	Oleander
<i>Photinia fraseri</i>	No common name
<i>Pittosporum tobira</i>	Tobira
<i>Plumbago auriculata</i>	Blue Cape Plumbago
<i>Rhamnus californica</i>	California Coffeeberry
<i>Raphiolepis indica</i>	Indian Hawthorn
<i>Raphiolepis ovata</i>	No common name
<i>Spirea thunbergi</i>	No common name
<i>Ternstroemia gymnanthera</i>	No common name
<i>Viburnum sp.</i>	Various
<i>Xylosma congestum</i>	Shiny Xylosma

---

**Small, 1 to 5 feet in height**

<i>Cistus hybridus</i>	White Rock Rose
<i>Cistus ladaniferus</i>	Crimson Spot Rockrose
<i>Cistus purpureus</i>	Orchid Spot Rockrose
<i>Dietes (Morea) vegeta</i>	Fortnight Lily
<i>Dietes bicolor</i>	
<i>Escallonia Compacta</i>	Dwarf Escallonia
<i>Myrtus communis compacta</i>	Compact Myrtle
<i>Pittosporum tobira Wheeleri</i>	Dwarf Tobira
<i>Polystichum munitum</i>	Western Sword Fern
<i>Ribes viburnifolium</i>	Catalina Currant
<i>Sarcococca ruscifolia</i>	Fragrant Sarcococca
<i>Xylosma congestum compactum</i>	Compact Shiny Xylosma

**GROUNDCOVERS**

<i>Arctostaphylos Emerald Carpet</i>	Emerald Carpet Manzanita
<i>Baccharis pilularis Twin Peaks</i>	Dwarf Coyote Brush
<i>Ceanothus griseus horizontalis</i>	Carmel Creeper
<i>Coprosma kirki</i>	No common name
<i>Cotoneaster dammeri Lowfast</i>	No common name
<i>Hedera helix Hahns</i>	Hahns Ivy
<i>Mahonia aquifolium compacta</i>	Compact Oregon Grape
<i>Mahonia repens</i>	Creeping Mahonia

**USE CRITERIA**

Plant roots occupy roughly the same volume of space below ground as their tops do above—though not necessarily in the same form.

Upright forms get up out of spaces while round or spreading forms tend to dominate or fill them.

Evergreen forms give the same amount of shade summer and winter, while deciduous forms let in the winter sun.

Trees above 30 feet in height develop large root crowns as they mature. These buckle sidewalks, curbs, and paving, and become difficult management problems. Fifty-foot trees need at least ten feet of open ground on all sides; 30- to 50-foot trees need at least seven to eight feet; under 30 need five feet.

Trees and shrubs in general are most difficult and demanding the closer they are to structures and to paving including walks, streets, parking areas, plazas, and patios. Problems include not only growth expansion but fruit, flower, and sap deposits. Generally the smaller and slower plants are easier to live with, although they may be more demanding of food and water, and need protection from larger neighbors. □

## Appendix C. General Plan Objectives and Policies

The text in the left-hand columns is quoted directly from Chapter 5, "Community Design," of the *Clayton: 2000 General Plan*, adopted July 17, 1985. The text in the right-hand columns represents the changes recommended in Chapter 2, "Land Use," of the *Town Center Specific Plan*, June 7, 1989, pages 17-20. Additions are shown in *italics*.

### Page V-2, Policy 2b

Identify areas where vegetation should be preserved.

### Page V-2, Policy 2b

*No change.*

### Page V-3, Policy 4c

Locate major arterials and collector streets on the periphery of the central area.

### Page V-3, Policy 4c

*Except for the extension of Marsh Creek Road north through the Town Center to intersect with the Clayton Road bypass, locate major arterials and collector streets on the periphery of the central area.*

### Policy 5a

Protect scenic vistas.

### Policy 5a

Protect scenic vistas *and view corridors.*

### Page V-4, TOWN CENTER

#### Objective 11

To create a cohesive village ambience within the Town Center.

### Page V-4, TOWN CENTER

#### Objective 11

To create a cohesive village ambience within the Town Center, *develop Main Street as a shopping street, with as few breaks in the shopping frontage as possible.*

#### *Objective 11.1 (added)*

*Provide a small but growing built-in market for Town Center commercial uses and personal services.*

**Policy 11d**

Designate the area within the Town Center as Town Center Commercial permitting either retail or office on the ground floor and residential on the second story subject to review for design and compatibility with adjacent uses.

**Page V-5, Policy 13a**

Reduce dependence on any single street in the Town Center by developing a northern bypass and upgrading Main and Center Streets for a traffic split.

**Page V-9, Clayton Road**

This route extends from Kirker Pass to the Town Center.

**Marsh Creek Road**

This route extends from the eastern limits to the Town Center.

**Concord Boulevard**

This route will extend from Kirker Pass to connect with Marsh Creek Road.

**Page V-15, TOWN CENTER BOUNDARY**

The Town Center will be the core of the commercial and administrative facilities serving Clayton. The present business area lies on both sides of Main Street and gener-

**Policy 11d**

Designate *areas* within the Town Center as Town Center Commercial. *This will permit retail, restaurants, personal services, and offices on the ground floor (except that ground floor offices on Main Street will be subject to the granting of a use permit), and all of those uses plus residential on the second story.*

**Page V-5, Policy 13a**

Reduce dependence on any single street in the Town Center by developing a northern bypass.

**Page V-9, Clayton Road**

This route extends from Kirker Pass Road around the Town Center to connect with Marsh Creek Road southeast of the central area.

**Marsh Creek Road**

This route extends from the eastern limits through the Town Center to connect with Clayton Road.

*Deleted*

*Deleted.*

**Page V-15, TOWN CENTER BOUNDARY**

*No Change.*

ally extends from Oak Street east to Marsh Creek Road. The district features a number of older residences and small retail uses. Commercial zoning currently exists on both sides of Main Street.

From a design standpoint, the Town Center limits should be based on limits that are readily apparent. These factors include physical topography of creeks and hillsides, circulation features, existing land use patterns and adequate area to provide necessary transition or buffer between the Town Center and residential areas.

The Town Center boundary, particularly after the area has been developed, should be clear to the average observer as well as the land owner. Land uses, landscape, roads and other features are used to reinforce the Town Center concept and boundary.

Exhibit V-3 provides the physical characteristics of the Town Center area. Exhibit V-4 provides the land use patterns of the Town Center area. Exhibit V-5 provides the proposed limits for the Town Center based on considerations mentioned above.

Boundaries to the Town Center that are visually clearest are to the west and north. The west side of the center area is reinforced by hillside, creek and city ownership. The north side is delineated by the confluence of Mitchell and Mt. Diablo Creeks which create a vegetative edge. The eastern boundary is limited by Mt. Diablo Creek and existing residential development. The boundary to the south is limited by an increase in elevation; however, the boundary is indefinite along Oak Street and Marsh Creek Road. This is where care

*No change.*

*No change.*

Exhibit V-3 provides the physical characteristics of the Town Center area. Exhibit V-4 provides the land use patterns of the Town Center area. Exhibit V-5 shows the proposed limits for the Town Center.

Boundaries to the Town Center that are visually clearest are to the west and north. The west side of the center area is reinforced by hillside, creek and city ownership. The north side is delineated by the confluence of Mitchell and Mt. Diablo Creeks which create a vegetative edge. The eastern boundary is the Clayton Road bypass. The boundary to the south is marked by an increase in elevation. The southern boundary shall be as follows: on the west side of Marsh Creek Road, the south right-of-way line of High Street, and that line ex-

must be taken to establish the limits of the Town Center to prevent strip development. The southern boundary shall be the southerly limits of Village Oaks and the PT&T building.

There are two exceptions to the Town Center limit. First, it may be necessary to extend the designation to the DeMartini Winery to enhance its viability as a facility. Second, an isolated site for commercial development has been approved previously at Mountaire Parkway and Marsh Creek Road. The area between the commercial site at Mountaire and the PT&T building should remain residential to prevent creation of a commercial strip.

#### TOWN CENTER CIRCULATION

Circulation issues that will affect the design and character of the Town Center area include the arterial configuration for through and local traffic, collector street location, boardwalk and sidewalk design, parking location and greenbelt system integration. Town Center circulation features are provided in Exhibit V-6.

##### Arterials

Basic to the concept for the development of a unified pedestrian-oriented Town Center was the decision in previous plans to relocate through traffic from Main Street one block south to Center Street. The current pattern provides a mix of traffic on Main Street. The advantages of this pattern are its historical use and high visibility of existing business. The disadvantages of this pattern are division of the downtown area, mixture of local and through traffic, con-

*tended east to Marsh Creek Road; on the east side of Marsh Creek Road, the south parcel line of the Lemke property and the south right-of-way line of Center Street.*

It may be necessary to extend the designation to the DeMartini Winery to enhance its viability as a facility. Second, an isolated site for commercial development has been approved previously at Mountaire Parkway and Marsh Creek Road. The area between the commercial site at Mountaire and the PT&T building should remain residential to prevent creation of a commercial strip.

#### TOWN CENTER CIRCULATION

Circulation issues that will affect the design and character of the Town Center area include the arterial configuration for through and local traffic, collector street location, sidewalk design, parking location and greenbelt system integration. Town Center circulation features are provided in Exhibit V-6.

##### Arterials

The current pattern provides a mix of traffic on Main Street. The advantages of this pattern are its historical use and high visibility of existing business. The disadvantages of this pattern are division of the downtown area, mixture of local and through traffic, congestion, high potential for accidents and difficulty in expanding upon the historic character.

gestion, high potential for accidents and difficulty in expanding upon the historic character.

**Page V-16, (Arterials continued)**

The Center Street alternative is indicated in Exhibit V-7. The advantages of this pattern are the historic commitment, the elimination of traffic from Main Street, the expansion of commercial area and the improvement of a poor roadway.

The disadvantages for this pattern of development are elimination of two houses, an imposition of a new pattern on existing uses, difficult curves for truck maneuvering, loss of commercial land to right-of-way expansion and costly road reconstruction.

The northern route alternative provides the main thoroughfare as indicated in Exhibit V-8. Its primary advantages are expansion of Town Center area to the north. There are no structures to acquire, a view of the Town Center is maintained and there is no impact on existing business except possibly the winery property.

Its disadvantages are unknown status of right-of-way, costly fill and roadway construction, possible condemnation needs, loss of land and negative impact on the winery.

Center Street has been the adopted route. A committee of town merchants and owners have strongly supported the northern alternative.

The Town Center Circulation Plan adopted by the 1984 General Plan Committee estab-

**Page V-16, (Arterials continued)**

*Deleted.*

*Deleted.*

*The adopted northern route is shown on Exhibit V-8. Its primary advantage is expansion of Town Center area to the north. There are no structures to acquire, and a view of the Town Center is maintained.*

*Delete.*

*Delete.*

*Delete.*

lished a compromise among the issues of Town Center circulation.

Main Street would remain the truck route at the present time and be expanded to an 80-foot right of way.

Center Street would be developed to a standard 60-foot right of way.

An additional 2 lanes would be routed up the grade between Main Street and the elementary school as environmentally sensitive a manner as possible. This would extend to a northern bypass built parallel to Main Street upon the development of Keller Ranch. At that time engineering and environmental studies will be used to insure the following:

- a. That there would be no significant adverse impact upon Cardinet Glen.
- b. That the route selected create the least adverse impacts.
- c. That the impact upon the meadow and area vegetation be reduced and mitigated.
- d. That environmental and aesthetic effects be considered and mitigated.

The Main Street connection between Marsh Creek Road and Clayton Road is ultimately planned to accommodate four travel lanes with parking on one side (or two bike lanes) on the portion of the road system within the Town Center. This will accommodate up to 24,000 cars per day when completed. The right-of-way should be obtained for the up-

*Clayton Road will become the truck route, and Main Street will be expanded to an 80-foot right-of-way.*

*Center Street will be developed in a 50-foot right-of-way west of Marsh Creek Road and a standard 60-foot right of way east of Marsh Creek Road.*

*Delete.*

*Delete.*

hill portion for widening to four lanes as needed.

Marsh Creek Road is also designated as an arterial in the circulation plan. It is planned to be a 60-foot roadway within an 80-foot right of way that will accommodate two travel lanes, two bike lanes and on-street parking until there is the need to provide four travel lanes.

Ultimate design of traffic through the Town Center area must include separation of through traffic from Town Center destination traffic.

**Page V-19, (Arterials continued)**

Design attention must be given to Clayton Road and Marsh Creek Road to maintain vistas and provide introduction to the upcoming Town Center. Placement of vegetation, directional signs and construction will provide the means to strengthen the Town Center image.

Main Street, between Oak Street and Marsh Creek Road, has a 70-foot right-of-way that can be used to accommodate two wide travel lanes (14 feet), two off-street parking bays (9 feet), two boardwalk/sidewalk/streetscape areas (12 feet). Changes in design will be considered in the subsequent engineering and design studies. Precise alignments will be determined based on circulation criteria.

**Boardwalks and Sidewalks**

A combination of boardwalks and sidewalks is proposed for all public streets.

*Delete.*

*The ultimate design of traffic through the Town Center is intended to separate through traffic from Town Center destination traffic.*

**Page V-19, (Arterials continued)**

*No change.*

*Main Street will be designed within an 80-foot right-of-way that can accommodate two wide travel lanes (13.5 feet), two rows of diagonal parking (16.5 feet each side), and two sidewalks (10 feet). Changes in design will be considered in the subsequent detailed engineering and design studies.*

**Boardwalks and Sidewalks**

*Delete.*

within the a Town Center. The boardwalks would be composed of wood, bomanite or other approved material or texture.

As Main Street is envisioned to be the major shopping street in the future, widths of 8 to 12 feet for the boardwalks are planned on this street. Sidewalks on other streets would have a minimum width of 5 feet. The intersections of Morris and Diablo with Main Street are proposed to have special paver treatment as primary pedestrian crossings. Design standards for sidewalks are provided in Appendix C.

### **Parking**

It is recommended that parking areas be constructed at strategic locations to intercept inbound shopper traffic from the major approach streets. In order that a pedestrian-oriented shopping area concept be implemented, there should be a minimum number of parking areas, located and landscaped in such a way that they do not become the dominant characteristic of the center, yet large enough that patrons do not have to drive from area to area in search of parking. Existing and proposed parking is indicated in Exhibit V-9. Parking design standards are provided in Appendix C.

### **Page V-23, EXISTING LAND USE**

The land uses of the Town Center are provided in Exhibit V-4. The sites and structures with historic merit in the Town Center

As Main Street is envisioned to be the major shopping street in the future, *sidewalks ten feet in width are planned on this street to accommodate the expected pedestrian volumes. On the south side of Main Street, in the vicinity of the eucalyptus grove or wherever the widened road and sidewalks might otherwise encroach on existing buildings, the sidewalk may be narrowed to five feet.* Sidewalks on other streets would have a minimum width of 7.5 feet.

### **Parking**

It is recommended that parking areas be constructed at strategic locations to intercept inbound shopper traffic from the major approach streets. In order that a pedestrian-oriented shopping area concept be implemented, there should be a minimum number of parking areas, located and landscaped in such a way that they do not become the dominant characteristic of the center, yet large enough that patrons do not have to drive from area to area in search of parking. *Parking existing in the Town Center in 1985 is indicated in Exhibit V-9. Parking design standards are provided in Chapter 5 of the Town Center Specific Plan.*

*(No change in the remaining paragraphs on page V-19.)*

### **Page V-23, EXISTING LAND USE**

*No change.*

are indicated in Exhibit V-10. The structures should be preserved and restored to the extent possible since they provide a link to the past and promote a diversity of appearance. Vegetation must also be preserved. The tall trees contribute to the rural feel of the community as well as provide physical landmarks signifying the Town Center.

### TOWN CENTER PLAN

The plan is indicated in Exhibit V-11. A series of uses will be incorporated into the plan. The primary designation will be Town Center (TC). It will permit the following uses:

#### Retail Commercial

Retail stores, specialty shops, convenience shopping facilities, restaurants, and service commercial.

#### Professional Office

Professional administrative offices, public and quasi-public facilities.

#### Accessory Uses

Medical and dental laboratories, printshops, storage facilities and similar support services. These uses will require review for compatibility with the retail/office functions of the Town Center.

#### Residential Uses

Second-story residential uses shall be permitted subject to review for design and compatibility.

### TOWN CENTER PLAN

The plan is indicated in *Figures 2-1 and 4-3 of the Town Center Specific Plan*. A variety of uses will be incorporated into the plan. The primary designation will be Town Center (TC). *The permitted uses are listed in detail in Chapter 2 of the Town Center Specific Plan.*

*Deleted.*

*Deleted.*

*Deleted.*

*Deleted.*

*Deleted. However, the second column on page V-23 is retained with no changes. □*

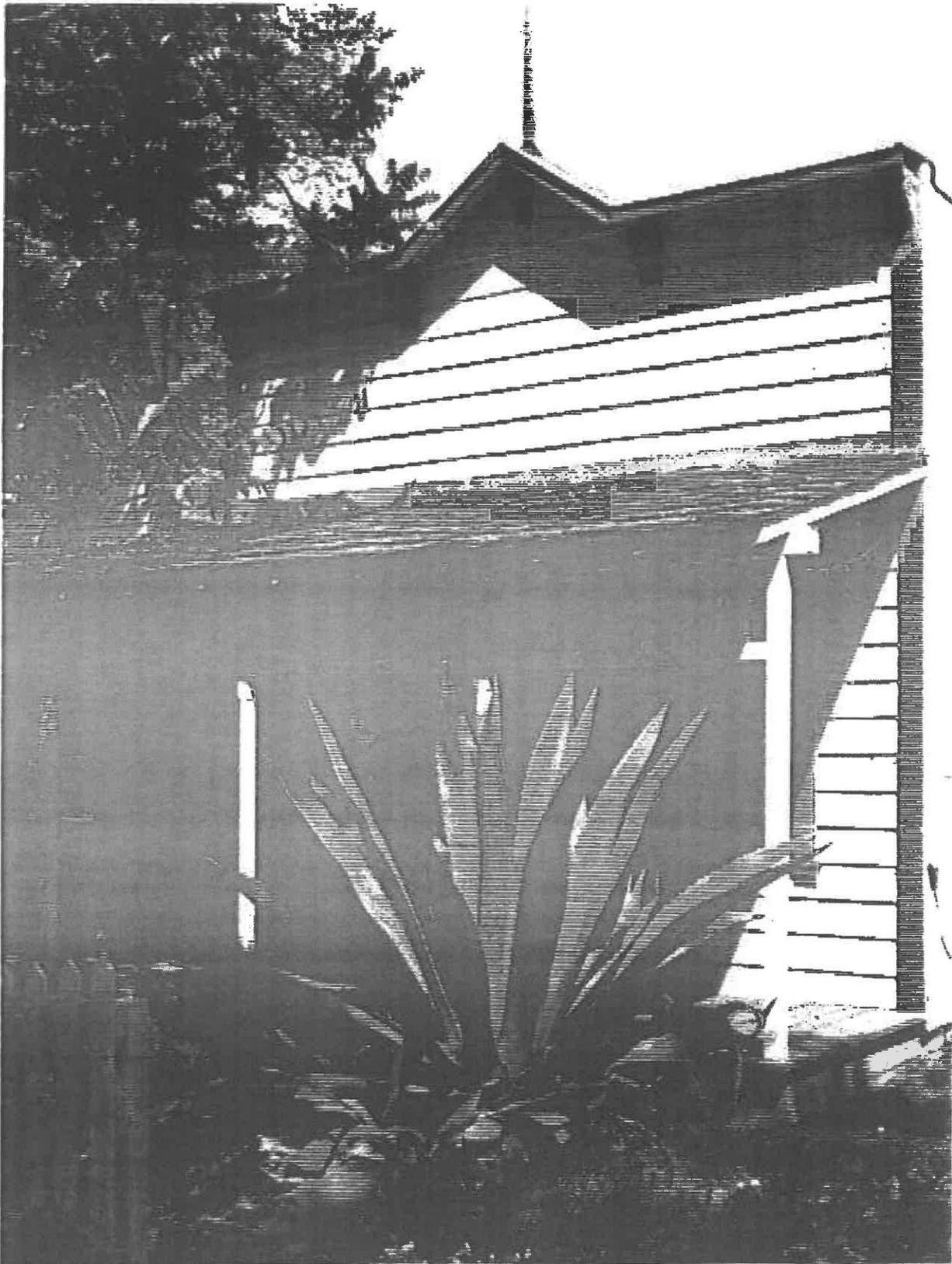

## Appendix D. Designating and Acquiring Private Property for Public Benefit

California law requires cities to adopt general plans and allows them to adopt specific plans, and further authorizes revisions to these general and specific plans. Through Land Use Planning, a long range, comprehensive policy statement describing a community's future physical development is prepared and adopted. The California Supreme Court noted in *Selby Realty Co. v. County of Sacramento* (10 Cal 3d at 119, 109 Cal Rptr. at 805, 1973) that long range planning is—by its nature—tentative, and its adoption is “several leagues short” of an intention to condemn property.<sup>1</sup>

In the process of preparing general and specific plans (which have planning periods of five to 15 years), city and county governments in California are often in the position of designating certain private properties for future public benefit or use, while noting that other private properties (floodways, for example) will not be allowed to be used for any private purpose. Cities and counties have such authority, and merely designating on a general or specific plan that a private property is to become a future park, for example, does not constitute a public “taking” of private property by “inverse condemnation.”

Recently—especially in the 1970s and 1980s—the federal and California courts have heard a number of cases where property owners have sued governments, alleging (in general) that the governmental agencies involved have tried to use (or “take”) private property for public purposes without properly compensating the owners for their alleged permanent or temporary monetary losses. In some cases, the owners have attempted to claim that a government action (generally planning or zoning) removed part or all of the value of their land, and thus the government “took” or “inversely condemned” the property. Naturally, these owners sought to be compensated for what they saw as their loss of actual or potential property value or present or future income from their properties.

*This memorandum attempts to explain very briefly, and in lay language, how the land use planning process works in relation to property rights in California, and what constitutes a “taking” of private property by “inverse condemnation.”* Inverse condemnation is also known as an “implied taking” of private property for which the owner of subject property pleads entitlement to just compensation for interference with private property rights.

---

<sup>1</sup> Property owners naturally become concerned when they learn that a government is making plans that will lead to public use of their private property. Governments regularly use their powers of “eminent domain” to openly and directly acquire, and pay fair market value for, privately owned land needed for public improvements, as in the case of highways or sewer plants. However, outright purchase in “fee title” is only one way to acquire the use of land. Cities, counties, and special districts have acquired easements (for road, trail, and open space purposes, for example), and property owners have dedicated land or easements to governments for specific uses under specific terms.

California case law defines the time when an inverse condemnation suit is ripe as that point when public action has occurred that is "direct and specific," such as the adoption of a *resolution of necessity* to proceed with acquiring private property by means of eminent domain (California Code Civil Procedures, Sect. 1245.260). When a city adopts such a resolution, it has six months to file an eminent domain suit. A property owner then has a year to file an inverse condemnation suit. The law is rapidly evolving in this area, however, and it is not clear precisely what public action is direct and specific enough to constitute an implied taking. Nevertheless, *adoption of a land use plan is clearly not enough to constitute an implied taking.*

Because any land use designation in a general plan is subject to change through a number of processes (legislative, E.I.R., public hearing, or inter-agency review, to name a few), private property owners whose land has been designated for public use in a general plan typically have not been successful in inverse condemnation lawsuits.

To prevail in an inverse condemnation lawsuit, a property owner must prove that there was direct and substantial interference with his or her property rights. For instance, such was the case in *Elks Hall Assoc. v. Richmond Redevelopment Agency* (561 F2d 1327, 9th Circuit, 1977) where, after adopting a redevelopment plan, the Agency began acquiring and demolishing property in the redevelopment area which included land surrounding plaintiff's property. This resulted in not only preventing the plaintiff from obtaining insurance or loans on his property, but also caused an exodus by those tenants who found out about the scheduled acquisition. These factors resulted in a reduction of rental income to the property owner, and the owner prevailed in this case.

Another successful inverse condemnation lawsuit occurred in *Jones v. People ex rel Department of Transportation* (22 Cal 3d 144, 148 Cal. Rptr. 640, 1978) which involved a freeway route plan that resulted in the Transportation Department depriving a property owner of the right to subdivide for a housing development by preventing him from gaining the necessary access to local streets.

Of note, however, is the case of *Taper v. City of Long Beach* (129 Cal. App.3d 590, 181 Cal. Rptr 169, 1982). There the question of damages for the unreasonable denial to a property owner of the right to develop her property due to publicly disseminated pre-condemnation announcements and activities by the city to acquire the property for a park (in disregard of a prior agreement between the owner and city), excluded any period of delay attributable to proper land use and fiscal planning. Similarly, in *Guinnane v. City and County of San Francisco* (197 Cal.App. 3d 862, 241 Cal Rptr. 787, 1987), a city delay in acting on a developer's building permit application in order to study the possible acquisition of the property for a city park was held not to constitute a taking.

"A California court has finally decided the takings issue in *First English*, the landmark case in which the United States Supreme Court held that landowners may recover damages for temporary takings.<sup>2</sup> The Supreme Court's 1987 decision set forth this

general rule but did not determine whether the ordinance in question actually effected a taking. The state court has now decided this issue, ruling that the Los Angeles County ordinance in question did not 'take' the Church's property, and thus the Church is not entitled to compensation. *First English Evangelical Lutheran Church v. County of Los Angeles*, 89 Daily Journal D.A.R. 6876 (1989)."

"The court applied the traditional takings test, pursuant to which a land use measure will effect a taking if it does not substantially advance a legitimate state interest or if it denies an owner economically viable use of his land. The County ordinance was designed to prevent human injury and death, described by the court as the 'highest possible public interest.' The court contrasted this interest with lesser public interests such as preventing premature development which had previously been determined to be legitimate public interests in the takings context."

"The *First English* decision links the determination of viable use to the public interest at stake. If the governmental action protects human lives and health, and there is no use of the property which would not threaten human lives or health, the government could deny a private owner all use of its property. Compensation would only be required for the denial of all economically viable use where the land use regulation advances lesser public purposes, such as preserving open space, preventing urbanization, or achieving aesthetic goals. Thus, the economically viable use test as applied in California courts probably will not be based upon any economic determination relating to a particular property, but rather on a balancing of the remaining uses and the strength of the public interest."

#### **RELATION TO THE TOWN CENTER SPECIFIC PLAN**

The Town Center Specific Plan designates various parcels for "public" land use. These include the City Hall, fire station, library, "the grove," and an area for public parking south of Clayton Road.

Presley of Northern California, a major property owner in the Town Center, is contractually obligated to provide (1) a site for the fire station and (2) either a site or *in lieu* fees for the City Hall. The Specific Plan represents the first step in the planning process for determining the location of and the amount of land needed for these two facilities. In the event a site other than one owned by the Presley Corporation is selected for the City Hall, the City and Presley will enter into negotiations leading to the trade or purchase of land and/or establishing the amount of the *in lieu* payment. □

---

<sup>2</sup> This and the concluding paragraphs are excerpted from McCutchen, Doyle, Brown & Enersen, *McCutchen Update, Legal Developments of Importance to our Clients*, June 13, 1989.



## Appendix E. Summary Of The Market Analysis for the Clayton Town Center Specific Plan

Downtown Clayton today has an estimated 41,600 square feet of retail and office space. The Market Analysis recommends that 86,000 square feet of additional space be included in the Town Center Specific Plan. This amount of space would more than triple the existing space in the Town Center area.

This appendix briefly describes the information and judgments that were used to derive the 86,000 square foot estimate and the factors that influence their accuracy.

### ***ESTIMATE OF COMMERCIAL SPACE THAT COULD BE SUPPORTED IN CLAYTON TOWN CENTER***

The estimate that 86,000 square feet of additional space could be supported is based fundamentally on three factors:

- The number of households that are expected to live in the primary market area served by a Clayton Town Center.
- The expenditures that market area households are expected to make locally for the types of goods that are described in the market report.
- The likelihood that market area households will spend that money in Clayton Town Center instead of other locations.

#### **Number of Households In the Primary Market Area**

The market report considered a primary market area that encompasses all households east of Mitchell Canyon Road and within 1.5 miles north, south, and east of the Town Center. This approach recognizes that people are likely to shop in areas that are most convenient to where they live. Mitchell Canyon Road is approximately halfway between the Town Center and the intersection of Clayton Road and Ygnacio Valley Road, which has a large concentration of shopping opportunities.

This primary market area was estimated to have 1,140 households in 1988, and would have 2,735 households after buildout of the Oakhurst, Regency Meadows, and Greystone Estates projects. The increase in households in the primary market area would equal 140 percent of the existing households. An estimate of supportable space based solely on this growth would yield an estimate that a total of 99,800 square feet of building space could be supported in downtown Clayton. This total would add 58,200 square feet to the existing development.

### **Types of Space that Could Be Supported In Clayton Town Center**

The downtowns of smaller cities, such as Clayton, are primarily places for convenience shopping rather than comparison shopping. Therefore, the Market Analysis focused initially on the amount of space that would be needed to meet the demands of market area households for items usually purchased in grocery stores and drug stores and on restaurant meals.

Based on studies of other smaller city downtowns, however, the Market Analysis also recommends that space also be included for the following types of stores and services:

- prepared foods;
- hardware, home improvements and general merchandise;
- convenience specialty goods such as books and gifts;
- comparison specialty goods similar to the Saddlery;
- financial institutions; and
- services.

The Market Analysis recommends that a service station be included on a site along Clayton Road.

### **Adjustment for Probable Locations of Expenditures**

In addition to recognizing that people will shop where it is convenient, the Market Analysis recognizes that even people who live closer to the Town Center than to any other shopping area may have reasons for shopping in other areas some of the time. Some likely reasons are that other areas may offer different selections of goods, or may be able to satisfy a greater number of shopping needs in a single trip, or may be more attractive, or may be on the way to or from another destination (*e.g.*, work).

The Market Analysis assumes that Clayton Town Center will be able to capture 75 percent of the expenditures made by people who currently live in the primary market area and 50 percent of the expenditures of new residents. These assumptions are based on (1) the relative proximity of the households to Clayton Town Center compared to other shopping areas and (2) the alternative route (Oakhurst Boulevard) available to Oakhurst residents who wish to travel west without entering downtown Clayton.

Using these assumptions, the amount of supportable space in grocery stores, drug stores, and restaurants in Clayton Town Center is estimated in Table 5 on page 17 of the Market Analysis at 57,275 square feet, including existing space. This amount of space is 38 percent greater than the existing inventory.

The report also recommends that 29,325 square feet of space be provided to accommodate the other types of goods and services described above (such as convenience and comparison specialty stores, financial institutions, services, hardware, and prepared foods). This recommendation is based on the distribution of uses found in the successful downtowns of other smaller cities analyzed for this study.

### **ALTERNATIVE APPROACH TO ESTIMATING THE SUPPORT FOR COMMERCIAL SPACE**

In response to a question posed by the Town Center Specific Plan Committee about the accuracy of the Market Analysis estimate, an industry “rule of thumb” could be applied to verify the reasonableness of the 86,000 square foot figure. As a rule, the anchor tenants in neighborhood shopping centers—which range in size from 50,000 to 150,000 square feet—occupy approximately 50 percent of the space. In the commercial building program recommended by the Market Analysis for Clayton Town Center, the anchor tenants would be the grocery store and the drug store. The analysis indicates that they should have a total of about 35,000 square feet of additional building space. If they occupied half of the total additional space, then the Town Center would need 70,000 additional square feet.

Downtown Clayton, however, has always had more restaurants than would be expected in a town of its size or in a neighborhood shopping center. The Market Analysis recommends that the Specific Plan include 16,000 square feet of restaurant space. Adding this amount of space to the earlier total yields an estimate of 86,000 square feet of new building space.

### **ACCURACY OF THE ESTIMATE**

Although the two methods of investigation yield similar estimates, the figure of 86,000 square feet should not be assumed to be 100 percent accurate. Variations from the 86,000 square foot figure will occur if the actual population growth is different from the assumed growth; if spending patterns are different from those assumed; if the types of businesses that are included in the market program (summarized in Table 10 on page 39 of the Market Analysis—Figure 2-7 on page 17 of this Specific Plan) cannot find adequate support in Clayton, and are not replaced by other uses; or for other similar reasons.

It is reasonable to assume that the actual amount of additional space supportable in Clayton Town Center will be between 60,000 and 95,000 square feet. The range of error of the estimate is smaller on the high side than on the low. □

## **Appendix F. Amendments**

**The text, tables, and figures of the Town Center Specific Plan have been revised to incorporate the following amendments.**

<b>Resolution No. 65-98</b>	<b>Adopted December 1, 1998</b>
<b>Resolution No. 58-2001</b>	<b>Adopted September 18, 2001</b>
<b>Resolution No. 24-2004</b>	<b>Adopted June 1, 2004</b>
<b>Resolution No. 45-2005</b>	<b>Adopted July 19, 2005</b>
<b>Resolution No. 02-2007</b>	<b>Adopted January 16, 2007</b>
<b>Resolution No. 05-2008</b>	<b>Adopted February 5, 2008</b>
<b>Resolution No. 12-2012</b>	<b>Adopted April 3, 2012</b>